



## ZAMEK INTELIGENTNY

Instrukcja użytkownika  (PL)

## SMART LOCK

User manual  (EN)



Special Attention:

1. Mechanical keys please keep outdoor, just in case keys lock in doors.
2. Please charge for the battery when low wattage alarm.
3. Reading this manual carefully before installation, and keep it for future reference.

UWAGA:

1. Tradycyjne klucze powinny być przechowywane poza pomieszczeniem z inteligentnym zamkiem w obawie przed zatrzaśnięciem kluczy wewnątrz.
2. Pamiętaj o naładowaniu baterii - ostrzeżenie o niskim stanie baterii
3. Przeczytaj uważnie instrukcję przed instalacją zamka i zachowaj ją na przyszłość.

# ZAMEK INTELIGENTNY

PL

Instrukcja użytkownika

## 1. Budowa Zamka

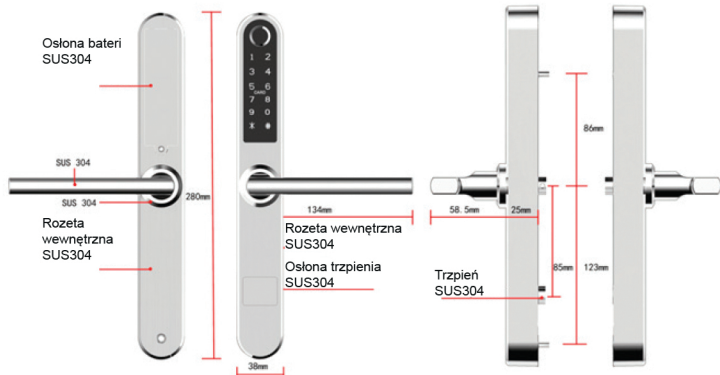

## 2. Wkładki

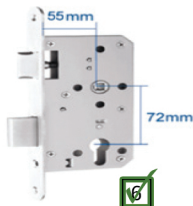
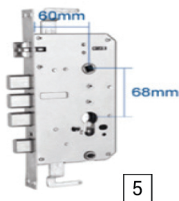

## 3. Instalacja

### 3.1. Schemat instalacji

Krok 1. Umieść wkładkę w drzwiach

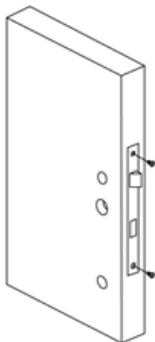

Krok 2. Zamontuj trzpień łączący klamki

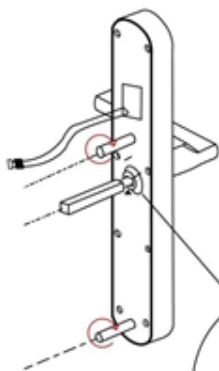

- 1) Jeżeli klamka jest skierowana w lewo strzałka powinna wskazywać L
- 2) Jeżeli klamka jest skierowana w prawo strzałka powinna wskazywać P

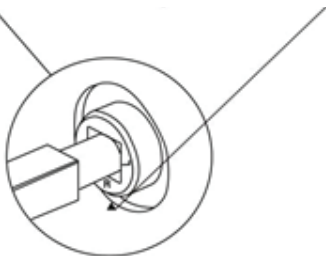

Krok 3. Zamontuj  
zewnątrzną rozetę

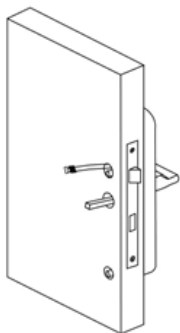

Krok 4. Zamontuj rozetę  
wewnętrzną

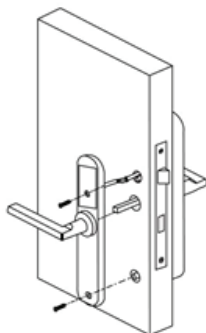

Krok 5. Włóż baterie

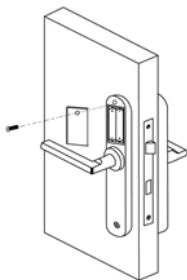

## 3.2 Zmiana kierunku klamki

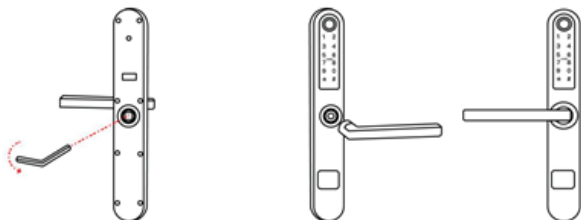

### Przełożenie klamki

W zewnętrznej rozecie

1. Poluzuj śrubę imbusową przeciwnie do ruchu wskazówek zegara
2. Zdemontuj klamkę
3. Dopasuj kierunek klamki. Następnie umieść ją w rozecie i przykręć imbus.

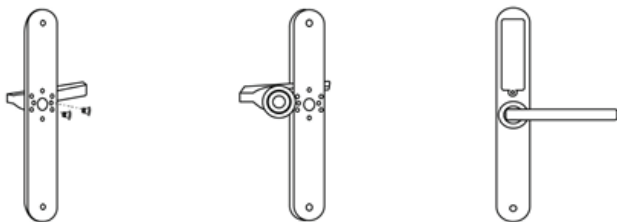

### Przełożenie klamki

w wewnętrznej rozecie

1. Odkręć dwie śruby mocujące klamkę
2. Zdemontuj klamkę
3. Dopasuj kierunek klamki. Następnie umieść ją w rozecie i przykręć śruby mocujące.

## 4. Specyfikacja

Zgodny z modelem	S31B
Materiał	SS304
Wymiar rozety zewnętrznej	280 x 38 x 25 mm
Wymiar rozety wewnętrznej	280 x 38 x 25 mm
Waga zamka	2.5KG
Możliwości odblokowywania	Bluetooth, Odcisk Palca, Hasło, Karta, Tradycyjny klucz
Kolory	Srebrny, Czarny, Złoty
Dedykowane do:	Drzwi aluminiowych, Drzwi drewnianych, Drzwi Przesuwnych, Drzwi wahadłowych
Zasilanie:	6V/4x AAA batteries
Grubość drzwi:	30-80 mm
Rozmiar pamięci	Nieokreślone
Dostosowane do pracy w temp:	-20C-70C
Wilgotność powietrza:	20%-90%
Ostrzeżenie o niskiej mocy	Mniej niż 4.5V

## 5. Rejestracja



## 5.1 Parowanie zamka z telefonem

1. Aby sparować urządzenia z systemem Android należy zeskanować kod QR widoczny wyżej
2. Dla urządzeń z systemem iOS, należy pobrać aplikację „TTlock” ze sklepu App Store
3. Zarejestruj użytkownika (numer telefonu lub Email) lub zaloguj się za pomocą istniejącego konta
4. Aby dodać nowy zamek wybierz „+ Add Lock” i wskaż typ urządzenia.
5. Zamki znajdujące się w pobliżu pojawią się na liście.
6. Zmień nazwę zamka, potwierdź „ok”
7. Jeśli konfiguracja przebiegła pomyślnie na ekranie pojawi się komunikat „Added Succesfully” Potwierdź klikając „Complete”

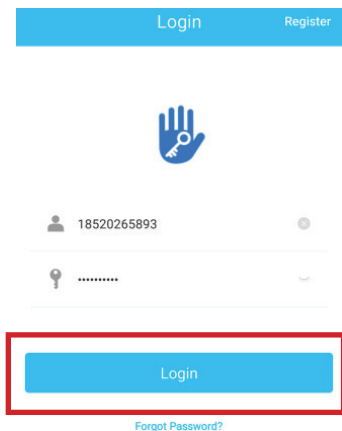

1-1

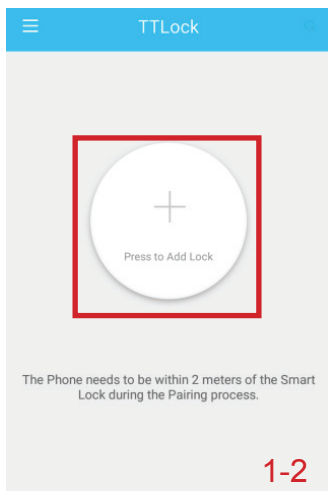

1-2



Choose Lock Type



Door Lock



Padlock



Safe Lock



Lock Cylinder



Parking Lock



Bicycle Lock

1-3

Add Lock

Lock Name

H50

1-5

OK

Nearby Locks



BL01\_63230b



S202C\_f4324e

1-4

Added Successfully

Added Successfully



Lock Name

H50

Battery

100%

1-6

Complete

## 5.2. Odblokowywanie (Tryb Administratora)

### 5.2.1 Odblokowywanie za pomocą bluetooth

Po sparowaniu telefonu z zamkiem, kliknij "  " (rysunek 2-1) aby odblokować zamek. (Telefon powinien znajdować się w odległości do 5 metrów)

### 5.2.2 Odblokowanie zdalne (Opcjonalnie)

Po potwierdzeniu, że telefon i zamek są połączone do tej samej sieci, kliknij  (rysunek 2-1 – aby odblokować). Możesz odblokować zamek z dowolnego miejsca jeżeli jesteś podłączony do sieci (Jak ustawić poprawnie sieć zobacz punkt 5.3)

### 5.2.3 Autoryzacja klucza Bluetooth

Kliknij na ikonę "  " (rysunek 2-1), możesz wysłać eKlucz do innych użytkowników TTlock aby autoryzować otwarcie zamka (odbiorca musi posiadać aplikację oraz posiadać konto/profil) > Wprowadź profil odbiorcy do TTlock, ustaw nazwę oraz czas w jakim eKlucz może zostać użyty (rysunek 2-2) > Wyślij > Konto odbiorcy ma uprawnienie do odblokowania zamka przez bluetooth

### 5.2.4 Odblokowanie poprzez hasło administratora

Kliknij  Settings (rysunek 2-1) > Wyświetl hasło administratora (Rysunek 2-3) > wprowadź hasło na klawiaturze > wciśnij "#" by odblokować.



### 5.2.5 Ustawianie haseł "dynamicznych"

Kliknij  Generate Passcode (Rysunek 2-1 > Rysunek 2-4) Możesz ustawić hasła czasowe, permanentne lub jednorazowe > Wygeneruj hasło > Wprowadź hasło odblokowania. **Nie wymaga dostępu do internetu**

### 5.2.6 Rejstr otwarć

Kliknij  Records (Rysunek 2-1) > Możesz przeglądać rejstr otwarć (Rysunek 2-5)

## 5.2.7 Odblokowanie na odcisk palca



Kliknij  (Rysunek 2-1) > Kliknij  > Dodaj odcisk palca > Ustaw nazwę oraz czas obowiązywania odblokowania > Start > Połóż palec na sensorze i postępuj zgodnie z instrukcją > Dodaj odcisk OK > Przyłóż swój odcisk palca do sensora aby odblokować zamek

## 5.2.8 Odblokowanie kartą

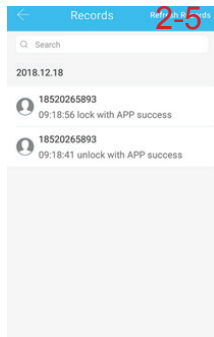
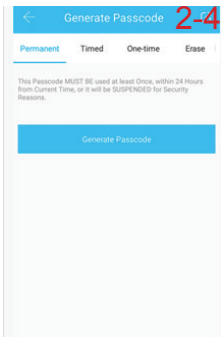
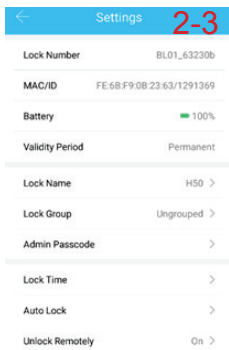
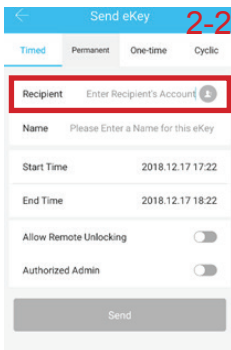
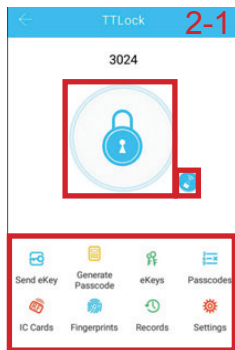
Kliknij  (Rysunek 2-1) > Kliknij  > Dodaj kartę IC (Rysunek 2-6)







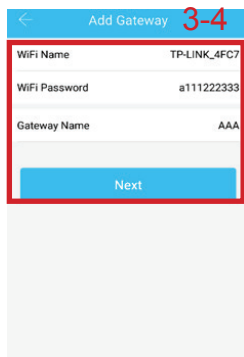
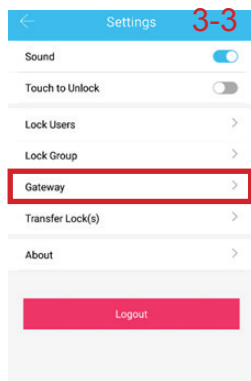
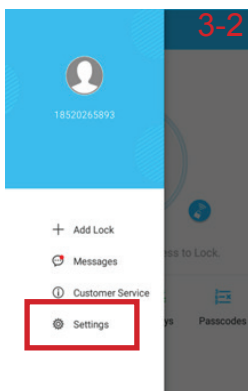
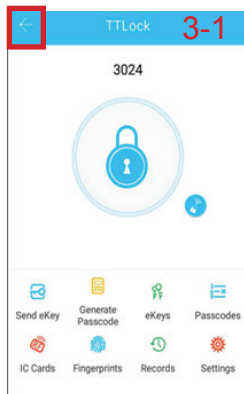







### 5.3 Skonfiguruj połączenie z siecią (Opcjonalnie)

Upewnij się, że telefon podłączony jest do sieci WI-FI > Kliknij  (Rysunek 3-1) > Kliknij  Settings (Rysunek 3-2) > Kliknij opcję "Gateway" (Rysunek 3-3) > Wprowadź hasło WI-FI oraz nazwę sieci (Rysunek 3-4) > Przytrzymaj klawisz „SETTING” do pojawienia się szybko migającej zielonej diody, następnie wciśnij opcję "Next" (Rysunek 3-5) > Instalacja zakończona



## 6. Lista elementów w zestawie

				
Nazwa	Rozeta zewnętrzna	Rozeta wewnętrzna	Instrukcja obsługi	Wkładka
Ilość	1	1	1	1
				
Nazwa	Zaczep drzwiowy	Wkręt	Klucz do drzwi	Karta dostępu
Ilość	1	4	2	2
				
Nazwa	Trzpień drzwi	Zawlecza	Śruba montażowa	Obudowa śruby eksagonowej
Ilość	1	1	2	2
				
Nazwa	Odbiornik			
Ilość	1 (Opcja)			

# SMART LOCK

User manual

EN

## 1. Lock Structure

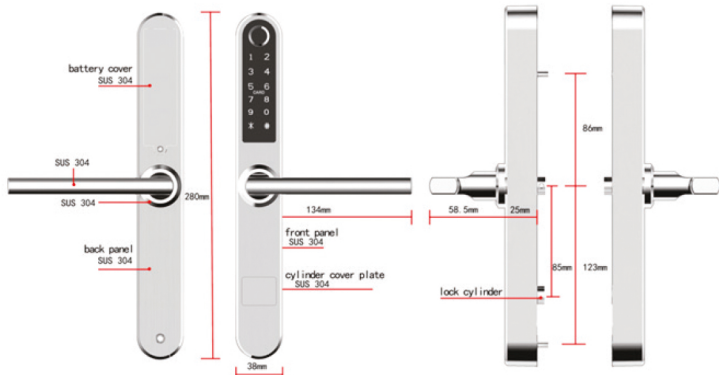

## 2. Mortise

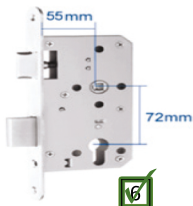
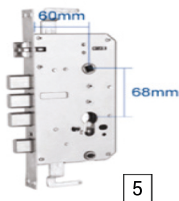

### 3. Instalation

#### 3.1. Installation Diagram

Step 1 Install Mortise

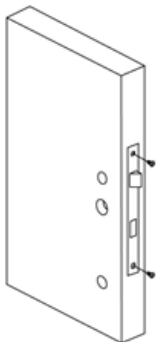

Step 2 Install Square Shaft And Hexagon Screw Casing

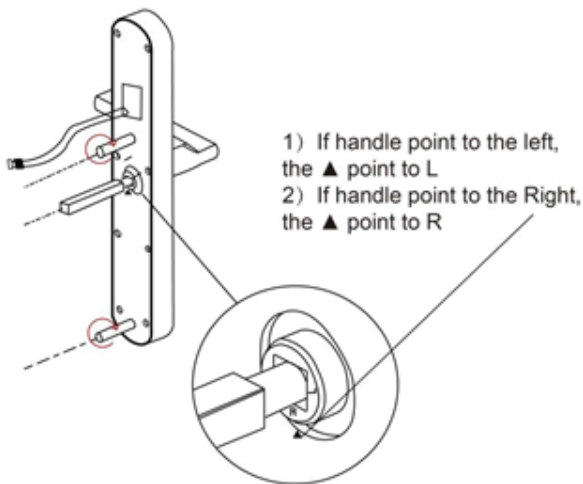

Step 3 Install FrontPanel

Step 4 Install Back Panel

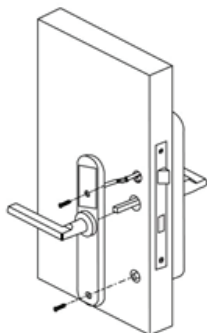
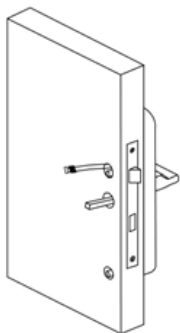

Step 5 Install the Battery

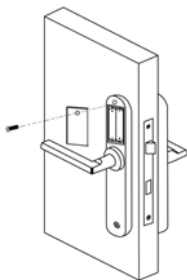



## 3.2 Turn the handle

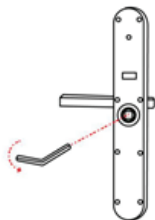

1、 Turn the handle on the front panel  
Loosen the inner hexagon screw of the handle counterclockwise

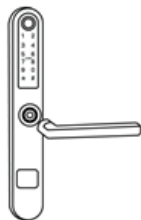

2、 Remove the handle

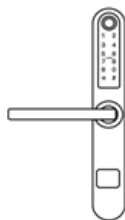

3、 After adjusting the direction of the handle, insert it into the handle seat and re-lock the hexagon screw of the handle to complete the turning



1、 Turn the handle on back panel  
Remove the two screws with a cross screwdriver



2、 Remove the handle

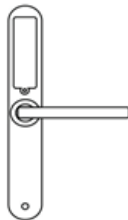

3、 After adjusting the direction of the handle, insert it into the handle seat and re-lock the two screws to complete the turning

## 4. Specifications

Suitable for Models	S31B
Materials	SS304
Front Panel Lock Size	280*38*25mm
Back Panel Lock Size	280*38*25mm
Lock Weight	2.5KG
Unlocking way	Bluetooth, Fingerprint, Password, Card, Mechanical key
Colour	Silver, black, Golden
Doors Applicable	Aluminum door, Wooden door, Sliding door, Swing door
Working Voltage	6V/4x AAA batteries
Door Thickness to Fit	30-80mm
Data Capacity	Not specyfied
Working Temperature	-20C -70C
Working Humidity	20%-90%
Low Wattage Alarm	Less than 4.5V

## 5. Registration



## 5.1 Connect lock to the phone

- 1) Android mobile phone, please scan the QR code as above
- 2) Apple mobile phone, please search "TTlock" from App Store.
- 3) Register a new account (phone number or email) or login with an existing account.
- 4) Touch the lock screen, click "+ Add Lock"
- 5) The lock nearby will appear on the phone screen, Click "+"
- 6) Re-name the lock
- 7) The lock added successfully

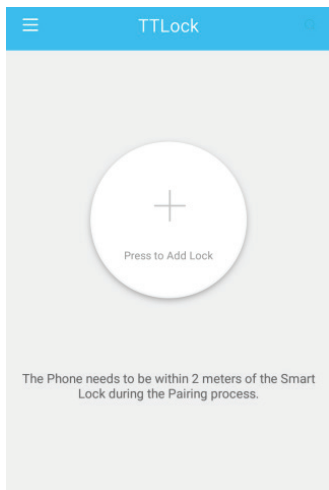
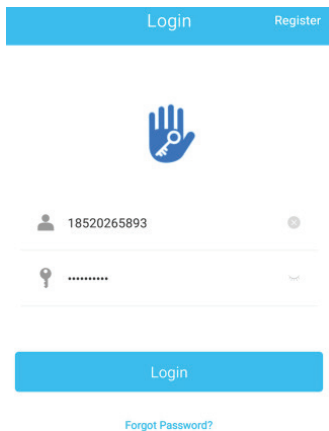

Choose Lock Type



Door Lock



Padlock



Safe Lock



Lock Cylinder



Parking Lock



Bicycle Lock

1-3

Nearby Locks



BL01\_63230b



S202C\_f4324e

1-4

Add Lock

Lock Name

H50

1-5

OK

Added Successfully

Added Successfully



Lock Name

H50

Battery

100%

1-6

Complete

## 5.2. Unlock(The Admin unlock)

### 5.2.1 Bluetooth unlock

After mobile phone and door lock connected, Click " " as show as figure2- 1 to unlock.(the phone is within 5meters from the door lock)

### 5.2.2 remote control unlock(Option)

After confirming that your phone and door lock are connected to the gateway,

Click " " as show as figure 2-1 to unlock. You can unlock it anywhere you have a network.(How to set up the gateway to connect to your phone refer to step 5.3)

### 5.2.3 Bluetooth key remote authorization

Click on the " " as shown in figure 2-1,you can send the eKey to other users of TTlock to authorize the unlock the receiver must be download the APP and resiter an account→ Enter recipient's account of TTlock,set the name and effective time of the eKey as shown in figure 2-2→Send→The recipient's account has bluetooth unlock permission

### 5.2.4 The Admin password unlock

Click " Settings " asv shown in figure 2-1 > See Admin Passcode as shown in finger2-3 input Passcode on the keypad of lock "#"to unlock.



### 5.2.5 Dynamic password unlock

Click " Generate Passcode " as shown in finger 2-1 > finger 2-4 You can set the effective time and effective number of passwords Generate password Input password to unlock. Does not require internet connection.

### 5.2.6 unlock records

Click " Records "as shown in finger 2-1 you can query your unlock record as shown in finger 2-5

## 5.2.7 Fingerprint unlock



Click "  " as shown in finger 2-1 Click "  "Add Fingerprint set the name and effective time of the fingerprint > Start >Place your finger on the sensor follow the instructions >Add fingerprint OK > Place your fingerprint on the sensor to unlock.

## 5.2.8 Card unlock

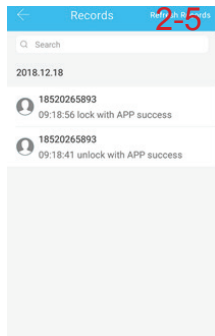
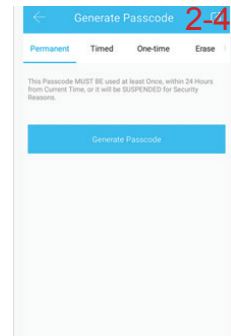
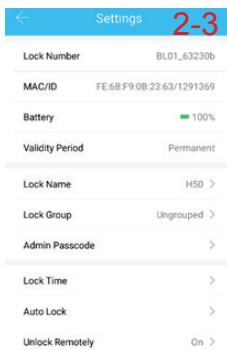
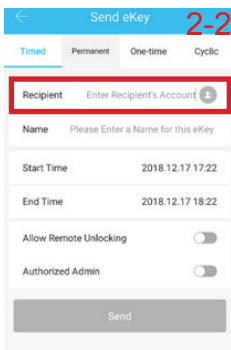
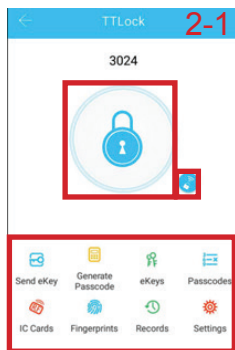
Click "  " as shown in finger 2-1>Click "  ">Add IC Cards as finger 2-6







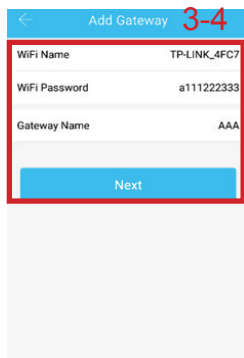
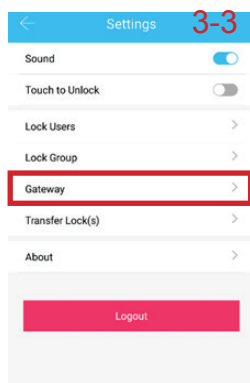
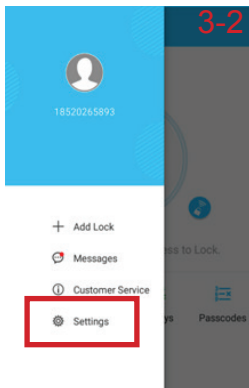
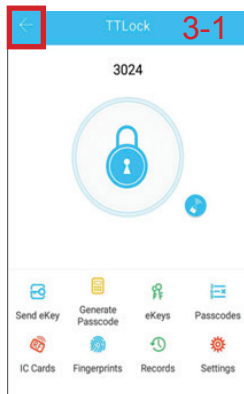







### 5.3 Set up the connection between the gateway and the phone(Optional)

Ensure your phone is connected to the desired WIFI network>Click "" as shown in finger 3-1>Click "" as shown in finger 3-2>Click "Gateway" as shown in finger 3-3> Enter WIFI password and Gateway name as shown in finger 3-4>Longer press the SETTING key until the Green LED blinks faster, then press "Next" as shown in finger 3-5>Setup complete



## 6. Lista elementów w zestawie

				
Nazwa	Rozeta zewnętrzna	Rozeta wewnętrzna	Instrukcja obsługi	Wkładka
Ilość	1	1	1	1
				
Nazwa	Zaczep drzwiowy	Wkręt	Klucz do drzwi	Karta dostępu
Ilość	1	4	2	2
				
Nazwa	Trzpień drzwi	Zawlecza	Śruba montażowa	Obudowa śruby eksagonowej
Ilość	1	1	2	2
				
Nazwa	Odbiornik			
Ilość	1(Optional)			



# Gwarancja

Imię i Nazwisko: \_\_\_\_\_

Telefon: \_\_\_\_\_

Data zakupu: \_\_\_\_\_

Nazwa urządzenia: \_\_\_\_\_

Model produktu: \_\_\_\_\_

## Adnotacje:

- 1) Zachowaj kartę gwarancyjną, aby móc z niej korzystać, gdy potrzebujesz serwisu gwarancyjnego.
- 2) Zapewniamy roczną gwarancję licząc od daty zakupu.
- 3) Usługa gwarancyjna jest ważna dla klientów w dowolnym kraju na świecie.

---

**Kratki.pl Marek Bal** ul. Gombrowicza 4, Wsola, 26-660 Jedlińsk, Poland  
tel. 00 48 48 389 99 00, 00 48 48 384 44 88, fax 00 48 48 384 44 88 wew. 106  
[www.kratki.com](http://www.kratki.com)

EAN

KOD VENDO

PW / 05/ 2019