



 **kratki** PRO

2024



As a business owner, I am extremely proud of the Kratki Pro line. It's not just the products, it's the true passion and commitment of our team to provide the highest quality home heating solutions. The Kratki Pro line is a symbol of modernity, efficiency and aesthetics that thousands of customers have already trusted. The decision to offer a **10-year warranty** was no accident. It is an expression of our full confidence in the durability and reliability of the products we create. Thanks to **advanced technology and innovative solutions**, fireplaces and stoves from the Pro line are not only a reliable source of heat, but also an important visual appeal of any interior, adding to its character and style.

We are particularly proud of the fact that our products are **the most popular and best rated by customers**. This confirms that the path we have taken, with **continuous development and striving for perfection**, is the right one.

KRATKI PRO is more than fireplaces - it is a **guarantee of peace, warmth, safety and satisfaction** for years.

March Bor



**QUALITY
COMFORT
ECOLOGY
SAFETY**

Kratki PRO is a **specially selected line** of fireplaces and free-standing stoves, for which the highest quality and guarantee of safety and comfort of use for customers were the most important for us. Based on experience, together with our Partners and installers, we have developed a group of products that are **recommended by the best PROfessionals** in the fireplace industry.



PRO LINE	6-7
LUCY PRO	8-9
LUCY PRO product features.....	10-11
FLOKI PRO	12-13
FLOKI PRO product features.....	14-15
MB PRO	16-17
MB PRO product features.....	18-19
NB PRO	20-21
NB PRO product features.....	22-23
NADIA PRO	24-25
NADIA PRO product features.....	26-27
VN PRO	28-29
VN PRO product features.....	30-31
ZOSIA PRO	32-33
ZOSIA PRO product features.....	34-35
LEO PRO	36-37
LEO PRO product features.....	38-39
PRO LINE STOVES	40-41
TOFA PRO	42-43
TOFA PRO product features.....	44-45
AB ENYO R & RW PRO	46-47
AB ENYO R & RW PRO product features.....	48-49
TORA PRO	50-51
TORA PRO product features.....	52-53
RUNA PRO	54-55
RUNA PRO product features.....	56-57
REN PRO	58-59
REN PRO product features.....	60-61
INGA PRO	62-63
INGA PRO product features.....	64-65
ERIK PRO	66-67
ERIK PRO product features.....	68-69
BJORN PRO	70-71
BJORN PRO product features.....	72-73
SVEN PRO	74-75
SVEN PRO product features.....	76-77
KARI PRO	78-79
KARI PRO product features.....	80-81
K11 PRO	82-83
K11 PRO product features.....	84-85
ACCESORIES AND PERSONALISATION	86-87
FIREPLACES - TECHNICAL PARAMETERS	88-91
BOILER FIREPLACES, STOVES - TECHNICAL PATAMETERS	92-93
DESIGNATIONS IN TABLES	94-95

Fireplaces and Stoves

PRO LINE

The **PRO** line is the answer to the needs of customers looking for a **premium product**. We have put our love for fire and more than **25 years of experience** in designing and manufacturing fireplaces. We have created the most beautiful designs, used the **highest quality materials** and the **latest technical solutions** on the market. All this to provide you with what most important in life - **peace, safety and independence**.



When you choose the Kratki Pro line, you get products that are not only the most popular among users, but also **enjoy the best ratings**. This testifies to their exceptional quality, durability and reliability.

Meticulous quality control at every stage of production, a series of tests and studies, both in our internal company laboratory, as well as independent certification bodies, ensures that **you get a product with the highest thermal efficiency and best combustion parameters**. Our fireplaces and freestanding stoves meet international environmental standards, including **Ecoprojekt, BImSchV 2 and Flamme Verte**.

Devices from the **KRATKI PRO line** have been recognized by the Competition Chapter for **the best Polish products and services**. The TERAZ POLSKA emblem is proof that we have taken the right path, and that our products and applied solutions **are valued by users and experts**. Winning such a significant award is the crowning achievement of the long-term process of improving the quality of our products.



PRO Line Fireplaces

LUCY

The LUCY line of fireplaces combines modernity with functionality, offering efficient use of heat and energy savings. They are versatile fireplaces, these inserts will fit perfectly into a variety of needs and spaces, from homes to commercial facilities. The grate hearth guarantees ease of operation and cleaning, while the triple aeration system of the combustion chamber and double deflector guarantee optimization of the combustion process.

The multitude of models in the LUCY line ensures that everyone will find the perfect solution to suit their requirements. From Slim models with a shallow combustion chamber, which are perfect for passive houses, living rooms with a small area and low heating power requirements. All the way up to a water fireplace with a capacity of up to 24 kW, which will provide efficient heating and domestic hot water for the entire house.



Scan the code
to find out more





Heating power range: **3 - 24 kW**

Heating efficiency: **up to 85%**

PRO Line Fireplaces

LUCY



Termotec lining:

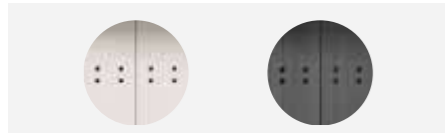

Version / glazing:

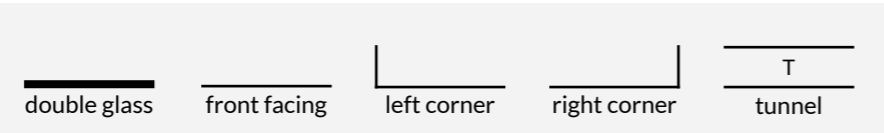

Meets Ecodesign requirements



Designed for recuperation



Compliance with the standard BImSchV2



LUCY 12
LUCY 12 BS L/P
LUCY 12 TUNEL

610x460



LUCY 14
LUCY 14 BS L/P
LUCY 14 TUNEL

760x460



LUCY 15

760x590



LUCY 16
LUCY 16 TUNEL

905x411



- 01. Rotary exhaust outlet** - the ability to rotate the flue by 360* allows you to position the insert in relation to the chimney without problems.
- 02. Resistant paint** - fireplace insert covered with a specially designed paint blend, with increased scratch resistance and characterized by a uniform and smooth texture, heat-resistant paint, does not emit odor.
- 03. Steel doors** made of closed profile, stable and resistant to stress.
- 04. Clean glass system** - the use of an air curtain allows you to keep the glass clean.
- 05. Decorative GLASS** gives modernity and elegance, optically enlarges the front of the insert and guarantees a perfect view of the fire.
- 06. Fireplace glass** - top-class heat-resistant ceramics from the renowned Schott brand. It is certified for quality and safety certificate.
- 07. Perforated handle** - its special design means that it does not get excessively hot.
- 08. Adjustable feet** that allow the fireplace to be leveled without problems. Adjustable to a height of 40mm.
- 09. External air supply** - supplying air exclusively from the outside. Regulation of the supply with a single regulator guarantees precise control of the combustion process.
- 10. Deflector** - the device is equipped with two deflectors. This increases combustion efficiency and guarantees better energy utilization.
- 11. TERMOTEC lining** - a material that ensures efficient combustion, accumulates heat and increases the temperature of the in the hearth. It gives the fireplace an elegant appearance. It is available in white or black color.
- 12. Ventilation of the combustion chamber** - an elaborate triple air supply system inside the fireplace, which allows for precise control of combustion.
- 13. Deepened combustion chamber** - a specially profiled, deepened bottom plate that provides comfort when loading wood. It prevents ash from falling out.
- 14. Ash pan and grate** - durable cast iron grate, under which there is a convenient and removable ash pan for easy maintenance clean



MODELS AVAILABLE IN SLIM VERSION:
LUCY 12 SLIM, LUCY 14 SLIM



BOILER FIREPLACES WITH WATER HEATER MODELS AVAILABLE:
LUCY 12 W PW, LUCY 16 W PW, LUCY 20 W PW

PRO Line Fireplaces

FLOKI

FLOKI fireplaces are smart fireplaces that ensure optimization of the combustion process thanks to an extensive supplemental aeration system. The proprietary Termotec material used as a fireplace lining accumulates heat and raises the combustion temperature. In turn, a unique clean glass system provides an unobstructed view of the flames.

The units are manufactured in a fully automated production process, thanks to which we guarantee the highest quality and unparalleled repeatability.

FLOKI fireplaces come in dozens of versions. We offer various types of glazing, and even ready-made modular buildings finished with quartz sinter. This allows everyone to find the right model for themselves.



Scan the code
to find out more



Heating power range: **3.5 - 14 kW**

Heating efficiency: **up to 85%**

PRO Line Fireplaces

FLOKI

Termotec lining:

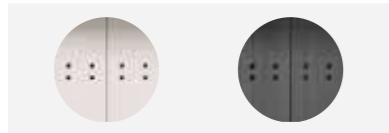

Version / glazing:

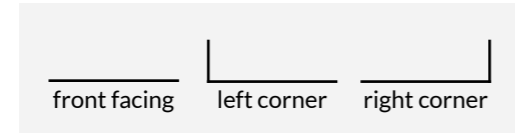

01. **Rotary exhaust outlet** - the ability to rotate the flue by 360° allows you to position the insert in relation to the chimney without problems.
02. **Resistant paint** - fireplace insert covered with a specially designed paint blend, with increased scratch resistance and characterized by a uniform and smooth texture, heat-resistant paint, does not emit odor.
03. **Steel doors** made of closed profile, stable and resistant to stress.
04. **Clean glass system** - the use of an air curtain allows you to keep the glass clean.
05. **Decorative GLASS** gives modernity and elegance, optically enlarges the front of the insert and guarantees a perfect view of the fire.
06. **Fireplace glass** - top-class heat-resistant ceramics from the renowned Schott brand. It is certified for quality and safety.
07. **Perforated handle** - its special design means that it does not get excessively hot.
08. **Adjustable feet** that allow the fireplace to be leveled without problems. Adjustable to a height of 40mm.
09. **External air supply** - supplying air exclusively from the outside. Regulation of the supply with a single regulator guarantees precise control of the combustion process.
10. **A vermiculite deflector**, that extends the flue gas path. This process also increases combustion efficiency and guarantees better energy utilization.
11. **TERMOTEC lining** - a material that ensures efficient combustion with material, accumulates heat and increases the temperature of the in the hearth. It gives the fireplace an elegant appearance. It is available in white or black color.
12. **Ventilation of the combustion chamber** - triple system of air supply to the interior of the fireplace, which allows for accurate control of combustion. Extended - air supplied through both the rear, as well as the side wall of the fireplace.
13. **Deepened combustion chamber** - a specially profiled, deepened bottom plate that provides comfort when loading wood. It prevents ash from falling out.
14. **Ash pan and grate** - durable cast iron grate, under which there is a convenient and removable ash pan for easy maintenance clean.



Meets Ecodesign requirements



Designed for recuperation



Compliance with the standard BImSchV2



FLOKI S
FLOKI S L/P

601x422

FLOKI M
FLOKI M L/P

732x419

FLOKI L
FLOKI L L/P

832x419

MODULAR OPTION FLOKI BOX

601x422

522x422

522x422

SINTERS

STANDARD



SINTERS

TO ORDER

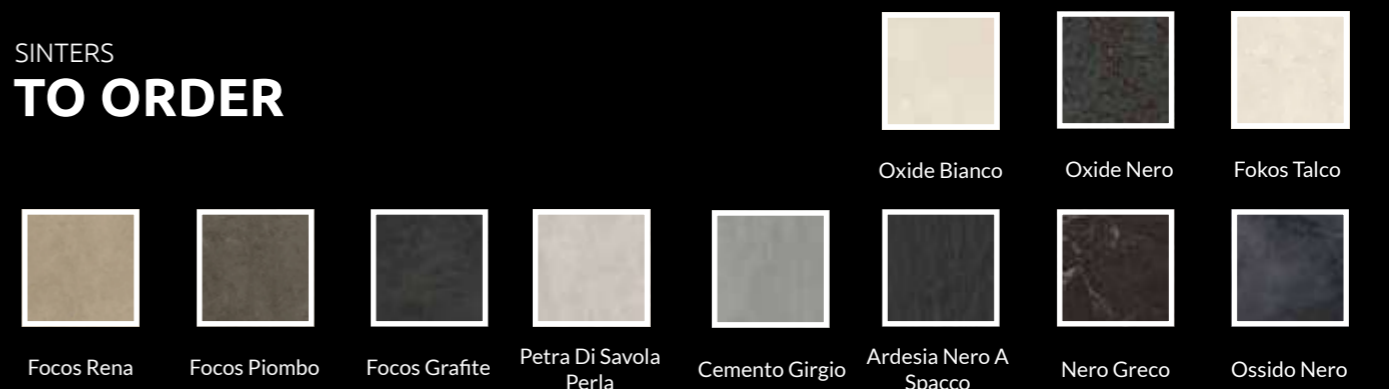

PRO Line Fireplaces

MB

The MB line represents a modern approach to home heating. These are fireplaces dedicated to the most demanding customers looking for an efficient and ecological solution. The uniqueness of MB fireplaces lies in the grateless technology, which ensures even combustion over the entire hearth surface, thereby maximizing the use of energy. Made of high-quality steel, the reinforced construction of the insert makes MB fireplaces ideal for implementation with accumulation masses and warm build-ups that allow for long-term heat retention.

The multitude of versions (90 models in the line!) differentiated by the type of glazing, door opening system or power range makes it possible to find ideal solutions for every need among MB fireplaces.



Scan the code
to find out more



Heating power range: **4 - 21 kW**

Heating efficiency: **up to 86%**

PRO Line Fireplaces

MB



Termotec lining:

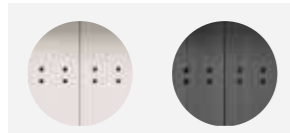

front facing right corner left corner right bent left bent double glass G front lift-up G left lift-up G right lift-up

Version / glazing:



Meets Ecodesign requirements



Designed for recuperation



Compliance with the standard BImSchV2



MBM
MBM BS L/P
MBM SG L/P
MBM G
MBM G BS L/P
MBM G SG BS L/P

535x413



MBZ
MBZ BS L/P
MBZ SG L/P
MBZ G
MBZ G BS L/P

584x474



MBO
MBO BS L/P
MBO SG L/P
MBO G
MBO G BS L/P

686x476



MBA
MBA BS L/P
MBA SG L/P
MBA G
MBA A BS L/P

686x536



MBN
MBN BS L/P
MBN SG L/P

457x474



MBN 680
MBN 680 BS L/P

402x626



- 01. Rotary exhaust outlet** - the ability to rotate the flue by 360° allows you to position the insert in relation to the chimney without problems.
- 02. Resistant paint** - fireplace insert covered with a specially designed paint blend, with increased scratch resistance and characterized by a uniform and smooth texture, heat-resistant paint, does not emit odor.
- 03. Steel doors** made of solid profile, which provides resistance to deformation under high temperatures
- 04. Clean glass system** - the use of an air curtain allows you to keep the glass clean.
- 05. Decorative GLASS** gives modernity and elegance, optically enlarges the front of the insert and guarantees a perfect view of the fire.
- 06. Fireplace glass** - top-class heat-resistant ceramics from the renowned Schott brand. It is certified for quality and safety.
- 07. Perforated handle** - its special design means that it does not get excessively hot.
- 08. Adjustable feet** that allow the fireplace to be leveled without problems. Adjustable to a height of 40mm.
- 09. External air supply** - supplying air exclusively from the outside. Regulation of the supply with a single regulator guarantees precise control of the combustion process.
- 10. Steel deflector** - which extends the path of the flue gas, lowers its temperature and results in better afterburning, allowing more heat to be recovered.
- 11. TERMOTEC lining** - a material that ensures efficient combustion, accumulates heat and increases the temperature in the hearth. It gives the fireplace an elegant look. It comes in white or black.
- 12. Ventilation of the combustion chamber** - an elaborate triple air supply system inside the fireplace, which allows for precise control of combustion.
- 13. Deepened combustion chamber** - a specially profiled, deepened bottom plate that provides comfort when loading wood. It prevents ash from falling out.
- 14. Insert without grate** - afterburning on ash, the fuel in the fireplace burns to a minimum amount of fine ash, which translates into maximum use of wood energy.
- 15. Flame tubes** - increase the heat transfer surface area and extend the circulation of flue gas flow. They contribute to lowering the temperature of flue gases, which translates into increased combustion efficiency and lower chimney losses.



LIFT-UP TYPE MODELS AVAILABLE:
MB100 G, MB120 G



BOILER FIREPLACES WITH WATER HEATER MODELS AVAILABLE:
MBM PW, MBM BS PW L/P, MBZ PW, MBZ BS PW L/P, MBO PW, MBO BS PW L/P, MBA PW, MBA BS PW L/P

PRO Line Fireplaces

NB

The NB series of fireplaces is an ideal choice for those looking for both energy efficiency and modern design. A key aspect of these fireplaces is that as much as 70% of the heat radiated is through the glass, which guarantees not only an excellent visual experience, but also efficient heating of the room.

NB inserts are equipped with a grate for easy cleaning of the combustion chamber, as well as a double door opening system „lift-up” up and side opening, which makes it easier to both load wood and clean the glass.

A distinctive feature of NB fireplaces is the large three-sided glazing, which provides an unforgettable view of the fire. In turn, the specially designed clean glass system significantly reduces soot deposition, keeping the cleanliness and an unobstructed view of the flames.



Scan the code
to find out more





Heating power range: **3 - 21 kW** Heating efficiency: **up to 84%**

PRO Line Fireplaces

NB

Termotec lining:

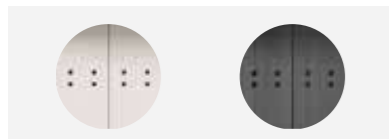

Version / glazing:

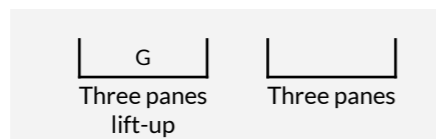

- 01. Rotary exhaust outlet** - the ability to rotate the flue by 360* allows you to position the insert in relation to the chimney without problems.
- 02. Resistant paint** - fireplace insert covered with a specially designed paint blend, with increased scratch resistance and characterized by a uniform and smooth texture, heat-resistant paint, does not emit odor.
- 03. Steel doors** made of closed profile, stable and resistant to stress.
- 04. Clean glass system** - the use of an air curtain allows you to keep the glass clean.
- 05. Decorative GLASS** gives modernity and elegance, optically enlarges the front of the insert and guarantees a perfect view of the fire.
- 06. Fireplace glass** - top-class heat-resistant ceramics from the renowned Schott brand. It is certified for quality and safety.
- 07. Lift Up System** - a proprietary door opening system that guarantees smooth raising and lowering of the glass. It ensures high comfort of the fireplace.
- 08. Adjustable feet** that allow the fireplace to be leveled without problems. Adjustable to a height of 40mm.
- 09. Convenience of use** - the door of the insert has a neat handle that allows you to easily open and close only selected panes.
- 10. External air supply** - supplying air exclusively from the outside. Regulation of the supply with a single regulator guarantees precise control of the combustion process.
- 11. Outlet aperture**, which extends the path of the flue gas. This process improves combustion efficiency and guarantees better energy utilization.
- 12. TERMOTEC lining** - a material that ensures efficient combustion, accumulates heat and increases the temperature in the hearth. It gives the fireplace an elegant look. It comes in white or black.
- 13. Ventilation of the combustion chamber** - an elaborate triple air supply system inside the fireplace, which allows for precise control of combustion.
- 14. Ash pan and grate** - durable cast iron grate, under which there is a convenient and removable ash pan for easy maintenance clean.
- 15. Flame tubes** - increase the heat transfer surface area and extend the circulation of flue gas flow. They contribute to lowering the temperature of flue gases, which translates into increased combustion efficiency and lower chimney losses.

OPTIONS / SINTERS

HOME EASY BOX



NADIA

The NADIA line of fireplaces combines elegance and innovation, offering models to suit different needs and tastes.

Nadia 14, with its spacious interior, is ideal for displaying a fire in large spaces, creating an unforgettable visual experience. Nadia 13, on the other hand, fits perfectly into traditional English portal buildings, giving interiors a classic charm. Nadia 8 and Nadia 9 offer an uncluttered, vertical vision of the fire - perfect for smaller spaces and alcoves next to chimneys. Nadia 10, with a more traditional form, blends well with tiled buildings, adding warmth and a homely atmosphere to the interiors.

All models of the NADIA line are characterized by even combustion over the entire surface of the hearth, thanks to the use of grateless technology. This solution not only makes it easier to keep clean, but also ensures more efficient use of heat.



Scan the code
to find out more



NADIA 13



NADIA 14 LBSG



NADIA K



Heating power range: **3 - 17 kW** Heating efficiency: **up to 82%**

PRO Line Fireplaces

NADIA



Termotec lining:

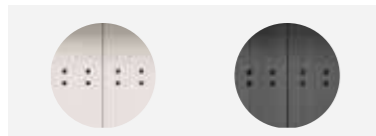

double glass front facing G front lift-up G left lift-up G right lift-up

Version / glazing:



01. **Rotary exhaust outlet** - the ability to rotate the flue by 360° allows you to position the insert in relation to the chimney without problems.
02. **Resistant paint** - fireplace insert covered with a specially designed paint blend, with increased scratch resistance and characterized by a uniform and smooth texture, heat-resistant paint, does not emit odor.
03. **Steel doors** made of closed profile, stable and resistant to stress.
04. **Clean glass system** - the use of an air curtain allows you to keep the glass clean.
05. **Decorative GLASS** gives modernity and elegance, optically enlarges the front of the insert and guarantees a perfect view of the fire.
06. **Fireplace glass** - top-class heat-resistant ceramics from the renowned Schott brand. It is certified for quality and safety.
07. **Handle** - The cartridge door has a modern slide handle.
08. **Adjustable feet** that allow the fireplace to be leveled without problems. Adjustable to a height of 40mm.
09. **External air supply** - supplying air exclusively from the outside. Regulation of the supply with a single regulator guarantees precise control of the combustion process.
10. **Steel deflector** - which extends the path of the flue gas, lowers its temperature and results in better afterburning, allowing more heat to be recovered.
11. **TERMOTEC lining** - a material that ensures efficient combustion, accumulates heat and increases the temperature in the hearth. It gives the fireplace an elegant look. It comes in white or black.
12. **Ventilation of the combustion chamber** - an elaborate triple air supply system inside the fireplace, which allows for precise control of combustion.
13. **Hexagonal combustion chamber** - the unique hexagonal chamber influences clean combustion, user comfort and improves energy efficiency, as it allows even heat distribution inside the fireplace.
14. **Insert without grate** - afterburning on ash, the fuel in the fireplace burns to a minimum amount of fine ash, which translates into maximum use of wood energy.

-  Meets Ecodesign requirements
-  Designed for recuperation
-  Compliance with the standard BImSchV2
-  Ability to change the opening side of the door

OPTION IN RUSTIC - TILE

NADIA MILANO

The Nadia fireplace insert dressed in retro-style tiles **fits perfectly into stylized interiors**. At the same time, thanks to its simple, geometric design, it **will also find its way into modern spaces**.

NADIA MILANO is a perfect combination of tradition and modernity. The casing made of tiles influences the **extension of the heat transfer time**, which is an additional source of heating after the hearth is extinguished.





PRO Line Fireplaces

VN

The VN line of fireplaces is synonymous with modernity and advanced technology.

Slim type inserts with side glazing and guillotine mechanism provide not only convenience of use, but also an excellent vision of the fire. They are ideally suited to smaller areas.

The solutions used, such as doors made of a closed profile, an extensive triple fireplace aeration system, a specially developed guillotine mechanism, a rotating flue outlet or adjustable feet, guarantee not only the highest quality, but also ease of installation.

Each model in the VN line is subjected to rigorous quality control so as to ensure durability and safety of use at the highest level.



Scan the code
to find out more



Heating power range: **3.5 - 17 kW**

Heating efficiency: **up to 84%**

PRO Line Fireplaces

VN

Termotec lining:

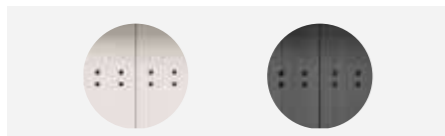

Version / glazing:

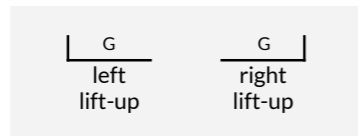

- 01. Rotary exhaust outlet** - the ability to rotate the flue by 360° allows you to position the insert in relation to the chimney without problems.
- 02. Resistant paint** - fireplace insert covered with a specially designed paint blend, with increased scratch resistance and characterized by a uniform and smooth texture, heat-resistant paint, does not emit odor.
- 03. Steel doors** made of closed profile, stable and resistant to stress.
- 04. Clean glass system** - the use of an air curtain allows you to keep the glass clean.
- 05. Decorative GLASS** gives modernity and elegance, optically enlarges the front of the insert and guarantees a perfect view of the fire.
- 06. Fireplace glass** - top-class heat-resistant ceramics from the renowned Schott brand. It is certified for quality and safety.
- 07. Lift Up System** - a proprietary door opening system that guarantees smooth raising and lowering of the glass. It ensures high comfort of the fireplace.
- 08. Adjustable feet** that allow the fireplace to be leveled without problems. Adjustable to a height of 40mm.
- 09. External air supply** - supplying air exclusively from the outside. Regulation of the supply with a single regulator guarantees precise control of the combustion process.
- 10. Deflector** - the device is equipped with two deflectors. This increases combustion efficiency and guarantees better energy utilization.
- 11. TERMOTEC lining** - a material that ensures efficient combustion, accumulates heat and increases the temperature in the hearth. It gives the fireplace an elegant look. It comes in white or black.
- 12. Ventilation of the combustion chamber** - an elaborate triple air supply system inside the fireplace, which allows for precise control of combustion.
- 13. Deepened combustion chamber** - a specially profiled, deepened bottom plate that provides comfort when loading wood. It prevents ash from falling out.
- 14. Ash pan and grate** - durable cast iron grate, under which there is a convenient and removable ash pan for easy maintenance clean.
- 15. Flame tubes** - increase the heat transfer surface area and extend the circulation of flue gas flow. They contribute to lowering the temperature of flue gases, which translates into increased combustion efficiency and lower chimney losses.



Meets Ecodesign requirements



Designed for recuperation



Compliance with the standard BImSchV2



VNL 480/480

452x452



VNP 480/480

452x452



VNL 610/430

582x430



VNP 610/430

582x430



VNL 700/480

672x490



VNP 700/480

672x490



VNL 810/410

782x490



VNP 810/410

782x490

PRO Line Fireplaces

ZOSIA

ZOSIA is a perfect combination of tradition and modernity. A fireplace insert with a large cast iron combustion chamber. Due to its airtightness, it is suitable for houses with recuperation. In addition, excellent technical parameters make it an insert that meets the requirements of the Ecodesign and the German BImSchV 2 standard.

Use is greatly facilitated by, among other things, a two-piece grate, a removable ash container, a protective bar to prevent wood from falling out, or a double back plate with easy removal of the inner back. Densely spaced heat sinks and hearth walls made of high quality 8 mm thick cast iron guarantee safe operation for years to come. An additional advantage of the fireplace is the extremely impressive and modern front of the insert, which guarantees a perfect vision of the fire.



Scan the code
to find out more



Heating power range: **6 - 15.5 kW**

Heating efficiency: **up to 83%**

PRO Line Fireplaces

ZOSIA

Version / glazing:

front facing



- 01. External heat sinks** - thanks to the use of such a solution, the heat transfer surface to the environment is much larger. At the same time, the weight of the fireplace is increased.
- 02. Resistant paint** - fireplace insert covered with a specially designed paint blend, with increased scratch resistance and characterized by a uniform and smooth texture, heat-resistant paint, does not emit odor.
- 03. Steel doors** made of closed profile, stable and resistant to stress. (applies to the ZOSIA DECO model).
- 04. Clean glass system** - the use of an air curtain allows you to keep the glass clean.
- 05. Decorative GLASS** gives modernity and elegance, optically enlarges the front of the insert and guarantees a perfect view of the fire.
- 06. Fireplace glass** - top-class heat-resistant ceramics from the renowned Schott brand. It is certified for quality and safety.
- 07. Perforated handle** - its special design means that it does not get excessively hot.
- 08. External air supply** - supplying air exclusively from the outside. Regulation of the supply with a single regulator guarantees precise control of the combustion process.
- 09. Deflector** - which extends the path of the flue gas, lowers its temperature and results in better afterburning, allowing more heat to be recovered.
- 10. Ventilation of the combustion chamber** - an elaborate triple air supply system inside the fireplace, which allows for precise control of combustion.
- 11. Removable fence**, that prevents wood from falling out of the hearth
- 12. Ash pan and grate** - durable cast iron grate, under which there is a convenient and removable ash pan for easy maintenance clean.
- 13. Double back plate** - with easy removal of the inner back.



Adjustment of the air supplied under the grate



Adjustment of the air intake supplied to the rear wall, the so-called secondary air



Meets Ecodesign requirements



Designed for recuperation



Compliance with the standard BImSchV2



ZOSIA PF

639x478



ZOSIA DECO

639x478



ZOSIA PW DECO

639x478

PRO Line Fireplaces

LEO

LEO gas fireplaces are perfect appliances that combine beautiful fire vision, warmth and a unique atmosphere, as in the case of wood fireplaces. In addition, unparalleled comfort of use, the joy of fire in a second at the click of a remote control or smartphone, and no restrictions.

By betting on LEO fireplaces, you are choosing innovative solutions that give you what matters most - peace of mind and safety. Hermetically sealed combustion chamber, gas shut-off system or specially designed ceramic burner take care of for trouble-free operation. Importantly, LEO fireplaces do not require an external power source, so they can operate even in the absence of electricity.

LEO gas fireplaces do not recognize limitations. They are adapted for burning both natural gas (mains) and from cylinders (LPG). If the house does not have a traditional chimney, LEO can be connected to a coaxial duct system. This makes installation possible in rooms without a chimney.



Scan the code
to find out more





Heating power range: **3.5 - 12.5 kW** Heating efficiency: **up to 91.9%**

PRO Line Fireplaces

LEO



Control by:

Version / glazing:

Smartphone Remote control

front facing left corner right corner Three panes tunnel tunnel left/right



LPG / NG
*depending on device version



Designed for recuperation



Independent power supply
*possibility to retrofit a power module



LEO 45/68 LEO 45/68 L/P LEO 45/68 LP 450x680	LEO 70 LEO 70 L/P LEO 70 LP 696x355	LEO 76/62 LEO 76/62 L/P LEO 76/62 LP 760x620	LEO 100 LEO 100 L/P LEO 100 LP LEO 100 TUNEL, TUNEL LP 1042x355	LEO 200 LEO 200 L/P LEO 200 LP 1952x357
--	---	--	--	---



01. **No restrictions** - the ability to connect the device to a coaxial duct system, making installation possible in rooms without a chimney.
02. **Steel frame** - precisely made of closed profile, stable and resistant to stress.
03. **Unobstructed vision of the fire** - thanks to the invisible frame of the facade and the minimal amount of visible steel elements.
04. **Remote control** - convenient control with a remote control or an app on a smartphone or tablet.
05. **Safety control system** - mechanisms that promote tightness and proper flow of gas in the fireplace system.
06. **Adjustable feet**, that allow the cartridge to be leveled without problems. Adjustable to a height of 50mm.
07. **Specially designed burner** - each of our models is equipped with the highest quality ceramic burner, which provides a realistic vision of the fire.
08. **Decorations as standard** - in the set with the fireplace you receive decorative ceramic woods imitating real logs.
09. **TRUEVIEW glass** - excellent glazing to enhance the intensity of the fire.
10. **Cleanliness** - no ash or dirty deposits - always clean glass and interior of the fireplace.
11. **Sealed combustion chamber** - a hermetically sealed combustion chamber that gives the highest degree of safety.
12. **Choice of fuel** - cartridge suitable for burning natural gas or LPG.

DECORATION

ADDITIONAL ACCESSORIES AND DECORATIONS FOR GAS FIREPLACES

CERAMIC SPLINTERS	CERAMIC FIR TREE	CERAMIC WOODEN STICKS	CERAMIC FLAKES BLACK FLAKES	CERAMIC FLAKES GREY FLAKES
LOGS CHARCOAL	IMITATION COAL	ORNAMENTAL PEBBLES TRANSPARENT CRYSTAL	ORNAMENTAL PEBBLES BLACK CRYSTAL	GLOW FLAME GLOW CELLS

PRO LINE

STOVES

Welcome to the world of **PRO line** stoves, where our passion, skills and experience translate into exceptional quality and innovation. Our stoves are the result of many years of intensive cooperation with Partners and installers. The devices are perfectly tailored to the different needs of customers. Thanks to the use of the latest technology and elegant design, each furnace from the **Pro line is synonymous with comfort and style**. We are confident in the **quality** and **reliability of our products**, which is why **we offer the longest 10-year warranty**.

Discover excellence and modernity with stoves from the **PRO line - where tradition meets innovation**.

REN



ERIK



BJORN



PRO Line Stoves

TOFA

TOFA stove combines advanced technology and design. It is ideal for those who prefer large wood loads, providing long-lasting heat without the need to frequently add fuel.

It features a clean glass system for an unobstructed view of the flames, and advanced technologies such as a double deflector system and a Thermotec material hearth that optimize combustion and heat accumulation. In addition, a triple aeration system, special door closing with a locking mechanism, and a removable ash drawer make it easier to operate and keep clean.

Adjustable feet and two options for mounting the exhaust outlet increase adaptability to different spaces. An alcove above the door is used to heat drinks, making the stove the center of home life.



Scan the code
to find out more



Heating power range: **6 - 10 kW**

Heating efficiency: **79%**

PRO Line Stoves

TOFA

Version / glazing:

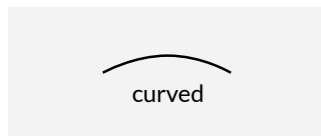

Termotec lining:

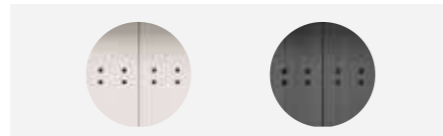

Meets Ecodesign requirements



Designed for recuperation



Compliance with the standard BImSchV2



- 01. Resistant paint** - fireplace insert covered with a specially designed paint blend, with increased scratch resistance and characterized by a uniform and smooth texture, heat-resistant paint, does not emit odor.
- 02. Steel doors** made of closed profile, stable and resistant to stress.
- 03. Fireplace glass** - top-class heat-resistant ceramics from the renowned Schott brand. It is certified for quality and safety.
- 04. Clean glass system** - the use of an air curtain allows you to keep the glass clean.
- 05. Decorative GLASS** gives modernity and elegance, optically enlarges the front of the insert and guarantees a perfect view of the fire.
- 06. Door closing as standard** - a mechanism implemented by a tension spring that generates the force needed to return the door to the closed position.
- 07. Railing** - a simple and aesthetically pleasing handle in the form of a slender rail, provides a comfortable grip along its length.
- 08. Feet** - adjustable leveling feet with plastic base.
- 09. Air supply from the outside** - air intake implemented by means of an external spigot (with the possibility of connection from the back as well as from the bottom).
- 10. Deflector** - the device is equipped with two removable deflectors. This increases the efficiency of combustion and guarantees better use of energy.
- 11. TERMOTEC lining** - a material that ensures efficient combustion, accumulates heat and increases the temperature in the hearth. It gives the fireplace an elegant appearance. It comes in white or black.
- 12. Ventilation of the combustion chamber** - an elaborate triple air supply system inside the fireplace, which allows for precise control of combustion.
- 13. Deepened combustion chamber** - a specially profiled, deepened bottom plate that provides comfort when loading wood. It prevents ash from falling out.
- 14. Ash pan and grate** - durable cast iron grate, under which there is a convenient and removable ash pan for easy maintenance clean.
- 15. Inspection door** - modernized mechanism for opening the lower door, changing from a magnetic mechanism to a latch with a roller and spring. The spring integrated into the latch allows you to open the front by pressing.
- 16. Top plate** made of 5mm thick steel



58.9 cm



126.2 cm

50 cm



PRO Line Stoves

RUNA

The RUNA stove provides efficient heating as well as a decorative interior feature. With one-time large loads of wood, users can enjoy warmth for a long time without the need to constantly add fuel. A clean glass system keeps the glazing clean, allowing uninterrupted admiration of the fire.

A double deflector system and a hearth lined with Termotec material significantly optimize the combustion process, ensuring heat accumulation and increasing energy efficiency. Facilitations such as a locking mechanism, door locking mechanism, deepened combustion chamber and special scratch-resistant coating increase the comfort of use and make it easier to keep clean. In turn, the possibility of installing the chimney connection from the top and rear of the device, adjustable feet or an enlarged opening in the base of the stove facilitate installation in different spaces.



Scan the code
to find out more



Heating power range: **6 - 10 kW** Heating efficiency: **80%**

PRO Line Stoves

RUNA

Version / glazing:

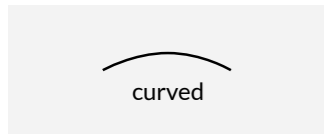

Termotec lining:

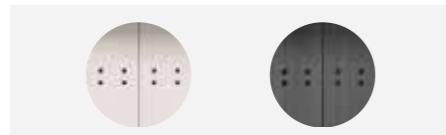

Meets Ecodesign requirements



Designed for recuperation



Compliance with the standard BImSchV2



- 01. Resistant paint** - fireplace insert covered with a specially designed paint blend, with increased scratch resistance and characterized by a uniform and smooth texture, heat-resistant paint, does not emit odor.
- 02. Steel doors** made of closed profile, stable and resistant to stress.
- 03. Fireplace glass** - top-class heat-resistant ceramics from the renowned Schott brand. It is certified for quality and safety.
- 04. Clean glass system** - the use of an air curtain allows you to keep the glass clean.
- 05. Decorative GLASS** gives modernity and elegance, optically enlarges the front of the insert and guarantees a perfect view of the fire.
- 06. Handle** - an integrated handle, invisible at first glance, discreetly integrated into the door frame.
- 07. Door closing as standard** - a mechanism implemented by a tension spring that generates the force needed to return the door to the closed position.
- 08. Feet** - adjustable leveling feet with plastic base.
- 09. Air supply from the outside** - air intake implemented by means of an external spigot (with the possibility of connection from the back as well as from the bottom).
- 10. Deflector** - the device is equipped with two deflectors. This increases combustion efficiency and guarantees better energy utilization.
- 11. TERMOTEC lining** - a material that ensures efficient combustion, accumulates heat and increases the temperature in the hearth. It gives the fireplace an elegant appearance. It comes in white or black.
- 12. Ventilation of the combustion chamber** - an elaborate triple air supply system inside the fireplace, which allows for precise control of combustion.
- 13. Deepened combustion chamber** - a specially profiled, deepened bottom plate that provides comfort when loading wood. It prevents ash from falling out.
- 14. Ash pan and grate** - durable cast iron grate, under which there is a convenient and removable ash pan for easy maintenance clean.
- 15. Top plate** made of 5mm thick steel
- 16. Freedom of installation** - possibility to install the exhaust outlet both from the top and the back of the device. Comes with a masking cap that allows flush installation with the top plate.



59.2 cm



125.2 cm

51.6 cm



PRO Line Stoves

SVEN

SVEN is a modern freestanding stove with a steel construction, which is distinguished by an elegant rounded glazing, further exposing the beauty of the flames. It meets high ecological standards - it complies with the requirements of Ecodesign, the German BlmschV II standard and Flamme Verte 7*, which guarantees efficient and clean combustion.

A system of two deflectors and TERMOTEC storage material ensure more efficient use of energy. The intuitive air supply control, cast iron grate and steel ash pan make it easy to use, while the clean glass system allows you to enjoy an uninterrupted view of the fire without the need for frequent cleaning.

SVEN is an ideal choice for demanding users looking for an ecological and efficient source of heat with a spectacular view of the fire.



Scan the code
to find out more



Heating power range: 4 - 10 kW

Heating efficiency: 75.7%

PRO Line Stoves

SVEN

Version / glazing:

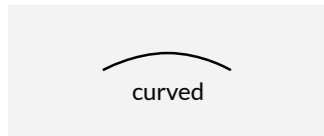

Termotec lining:

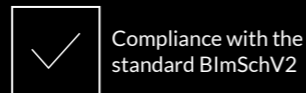
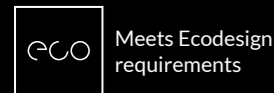
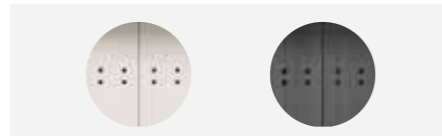

01. Resistant paint - fireplace insert covered with a specially designed paint blend, with increased scratch resistance and characterized by a uniform and smooth texture, heat-resistant paint, does not emit odor.

02. Steel doors made of closed profile, stable and resistant to stress.

03. Fireplace glass - top-class heat-resistant ceramics from the renowned Schott brand. It is certified for quality and safety.

04. Clean glass system - the use of an air curtain allows you to keep the glass clean.

05. Decorative GLASS gives modernity and elegance, optically enlarges the front of the insert and guarantees a perfect view of the fire.

06. Railing - a simple and aesthetically pleasing handle in the form of a slender rail, provides a comfortable grip along its length.

07. Feet - adjustable leveling feet with plastic base.

08. Air supply from the outside - air intake implemented by means of an external spigot (with the possibility of connection from the back as well as from the bottom).

09. Deflector - made of TERMOTEC, which extends the path of the flue gas, lowers its temperature and causes better afterburning, which gives the possibility of recovering more heat.

10. TERMOTEC lining - a material that ensures efficient combustion, accumulates heat and increases the temperature in the hearth. It gives the fireplace an elegant appearance. It comes in white or black.

11. Ventilation of the combustion chamber - an elaborate triple air supply system inside the fireplace, which allows for precise control of combustion.

12. Deepened combustion chamber - a specially profiled, deepened bottom plate that provides comfort when loading wood. It prevents ash from falling out.

13. Ash pan and grate - durable cast iron grate, under which there is a convenient and removable ash pan for easy maintenance clean.

14. Inspection door - modernized mechanism for opening the lower door, changing from a magnetic mechanism to a latch with a roller and spring. The spring integrated into the latch allows you to open the front by pressing.

15. Freedom of installation - possibility to install the exhaust outlet both from the top and the back of the device. Comes with a masking cap that allows flush installation with the top plate.

16. Top plate made of 5mm thick steel



PRO Line Stoves

ERIK

ERIK freestanding stove is a modern device with high thermal efficiency. It meets the strictest environmental standards: the criteria of Ecodesign, German BImSchV 2 and the requirements of Flamme Verte 7*.

The technological solutions used not only affect the comfortable use of the stove, but also facilitate its installation. The inspection door of the air intake connection on the basis of the "push to open" mechanism, adjustable feet for easy leveling or the possibility of connecting the fume outlet from the top or rear make the device easy to fit into any interior.

ERIK is an excellent choice for those looking for an efficient and ecological source of heat.



Scan the code
to find out more



Heating power range: **2.5 - 8.5 kW**

Heating efficiency: **80.5%**

PRO Line Stoves

ERIK

Version / glazing:

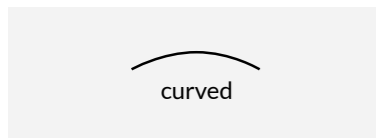

Termotec lining:

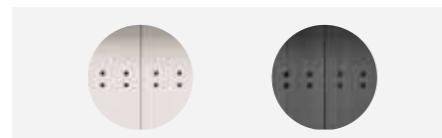

01. Resistant paint - fireplace insert covered with a specially designed paint blend, with increased scratch resistance and characterized by a uniform and smooth texture, heat-resistant paint, does not emit odor.

- 02. Steel doors** made of closed profile, stable and resistant to stress.
- 03. Fireplace glass** - top-class heat-resistant ceramics from the renowned Schott brand. It is certified for quality and safety.
- 04. Clean glass system** - the use of an air curtain allows you to keep the glass clean.
- 05. Decorative GLASS** gives modernity and elegance, optically enlarges the front of the insert and guarantees a perfect view of the fire.
- 06. Railing** - a simple and aesthetically pleasing handle in the form of a slender rail, provides a comfortable grip along its length.
- 07. Feet** - adjustable leveling feet with plastic base.
- 08. Air supply from the outside** - air intake implemented by means of an external spigot (with the possibility of connection from the back as well as from the bottom).
- 09. Deflector** - made of TERMOTEC, which extends the path of the flue gas, lowers its temperature and causes better afterburning, which gives the possibility of recovering more heat.
- 10. TERMOTEC lining** - a material that ensures efficient combustion, accumulates heat and increases the temperature in the hearth. It gives the fireplace an elegant appearance. It comes in white or black.
- 11. Ventilation of the combustion chamber** - an elaborate triple air supply system inside the fireplace, which allows for precise control of combustion.
- 12. Deepened combustion chamber** - a specially profiled, deepened bottom plate that provides comfort when loading wood. It prevents ash from falling out.
- 13. Ash pan and grate** - durable cast iron grate, under which there is a convenient and removable ash pan for easy maintenance clean.
- 14. Inspection door** - modernized mechanism for opening the lower door, changing from a magnetic mechanism to a latch with a roller and spring. The spring integrated into the latch allows you to open the front by pressing.
- 15. Freedom of installation** - possibility to install the exhaust outlet both from the top and the back of the device. Comes with a masking cap that allows flush installation with the top plate.
- 16. Top plate** made of 5mm thick steel

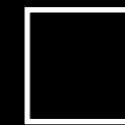
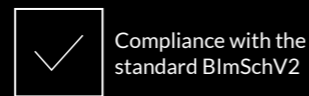
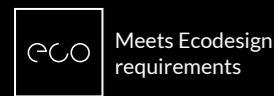

Black

ACCUMULATION CERAMICS

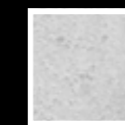

White Natural



White Satin



Grey Satin

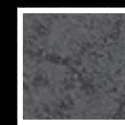

Grafite Satin



ERIK



ERIK W



DECORATIVE ACCUMULATION CERAMICS



WATER TURBODYMIUM



CAST IRON OR CONCRETE ACCUMULATION DISKS

PRO Line Stoves

AB ENYO

The stove is a response to growing market demands for energy efficiency and design. The high ecological standards of the device, confirmed by meeting the criteria of Ecodesign, BlmschV II and Flamme Verte, are the result of the use of an innovative supplementary aeration system and an advanced combustion mechanism. A number of technical solutions guarantee longer temperature maintenance, reduction of heat loss and clean combustion.

The stove is equipped with a number of features that make it easier to use and install: intuitive air supply control, cast iron grate, steel ash pan, clean glass system, adjustable feet and a locking mechanism that prevents the stove door from being accidentally left open.



Scan the code
to find out more



Heating power range: **2.5 - 8.5 kW**

Heating efficiency: **80.5%**

PRO Line Stoves

AB ENYO

Version / glazing:

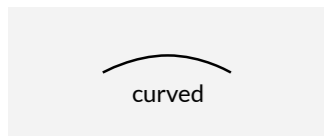

Termotec lining:

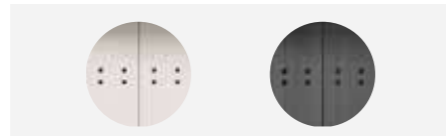

01. Resistant paint - fireplace insert covered with a specially designed paint blend, with increased scratch resistance and characterized by a uniform and smooth texture, heat-resistant paint, does not emit odor.

- 02. Steel doors** made of closed profile, stable and resistant to stress.
- 03. Fireplace glass** - top-class heat-resistant ceramics from the renowned Schott brand. It is certified for quality and safety.
- 04. Clean glass system** - the use of an air curtain allows you to keep the glass clean.
- 05. Decorative GLASS** gives modernity and elegance, optically enlarges the front of the insert and guarantees a perfect view of the fire.
- 06. Railing** - a simple and aesthetically pleasing handle in the form of a slender rail, provides a comfortable grip along its length.
- 07. Door closing as standard** - a mechanism implemented by a tension spring that generates the force needed to return the door to the closed position.
- 08. Feet** - adjustable leveling feet with plastic base.
- 09. Air supply from the outside** - air intake implemented by means of an external spigot (with the possibility of connection from the back as well as from the bottom).
- 10. Deflector** - made of TERMOTEC, which extends the path of the flue gas, lowers its temperature and causes better afterburning, which gives the possibility of recovering more heat.
- 11. TERMOTEC lining** - a material that ensures efficient combustion, accumulates heat and increases the temperature in the hearth. It gives the fireplace an elegant appearance. It comes in white or black.
- 12. Ventilation of the combustion chamber** - an elaborate triple air supply system inside the fireplace, which allows for precise control of combustion.
- 13. Deepened combustion chamber** - a specially profiled, deepened bottom plate that provides comfort when loading wood. It prevents ash from falling out.
- 14. Ash pan and grate** - durable cast iron grate, under which there is a convenient and removable ash pan for easy maintenance clean.
- 15. Inspection door** - modernized mechanism for opening the lower door, changing from a magnetic mechanism to a latch with a roller and spring. The spring integrated into the latch allows you to open the front by pressing.
- 16. Freedom of installation** - possibility to install the exhaust outlet both from the top and the back of the device. Comes with a masking cap that allows flush installation with the top plate.
- 17. Top plate** made of 5mm thick steel

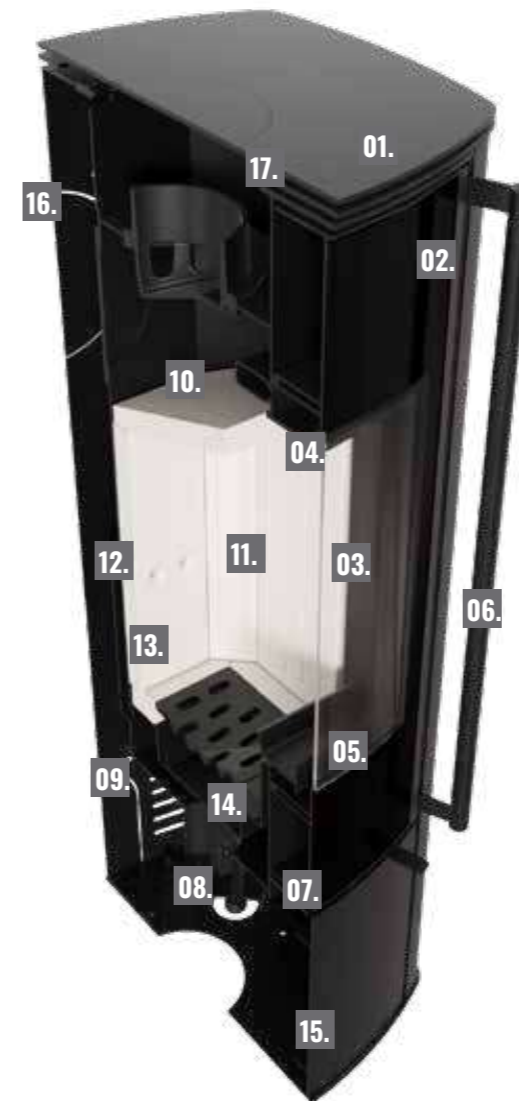

ACCUMULATION

WATER TURBODIUM AND ACCUMULATION DISCS AS AN ADDITIONAL OPTION



AB ENYO R



AB ENYO R W



AB ENYO R GAS



WATER TURBODIUM



3 CONCRETE DISKS



3 CAST IRON DISCS

PRO Line Stoves

BJORN

The BJORN stove, with its impressive large panoramic glazing finished in elegant black decor, is capable of heating up to 110 m². It meets the highest ecological standards of Ecodesign and Flamme Verte 7*.

The stove ensures extremely comfortable use, thanks to, among other things, a cast iron grate, a removable ash pan and a deepened and spacious combustion chamber that can accommodate logs up to 70 cm long. The TERMOTEC lining guarantees longer heat retention, while the triple aeration system not only optimizes the combustion process, but has also been designed so that the user will always enjoy a beautiful and unobstructed view of the fire.

BJORN is an attractive choice for the most demanding customers who care about a unique view of the fire and efficient heating.



Scan the code
to find out more



Heating power range: **5 - 11 kW**

Heating efficiency: **78.4%**

PRO Line Stoves

BJORN

Version / glazing:

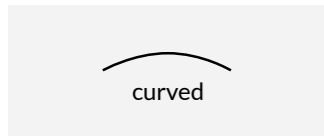

Termotec lining:

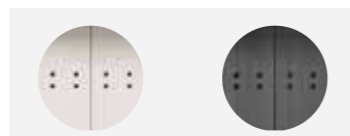

01. Resistant paint - fireplace insert covered with a specially designed paint blend, with increased scratch resistance and characterized by a uniform and smooth texture, heat-resistant paint, does not emit odor.

- 02. Steel doors** made of closed profile, stable and resistant to stress.
- 03. Fireplace glass** - top-class heat-resistant ceramics from the renowned Schott brand. It is certified for quality and safety.
- 04. Clean glass system** - the use of an air curtain allows you to keep the glass clean.
- 05. Decorative GLASS** gives modernity and elegance, optically enlarges the front of the insert and guarantees a perfect view of the fire.
- 06. Railing** - a simple and aesthetically pleasing handle in the form of a slender rail, provides a comfortable grip along its length.
- 07. Feet** - adjustable leveling feet with plastic base.
- 08. Air supply from the outside** - air intake implemented by means of an external spigot (with the possibility of connection from the back as well as from the bottom).
- 09. Deflector** - made of TERMOTEC, which extends the path of the flue gas, lowers its temperature and causes better afterburning, which gives the possibility of recovering more heat.
- 10. TERMOTEC lining** - a material that ensures efficient combustion, accumulates heat and increases the temperature in the hearth. It gives the fireplace an elegant appearance. It comes in white or black.
- 11. Ventilation of the combustion chamber** - an elaborate triple air supply system inside the fireplace, which allows for precise control of combustion.
- 12. Deepened combustion chamber** - a specially profiled, deepened bottom plate that provides comfort when loading wood. It prevents ash from falling out.
- 13. Ash pan and grate** - durable cast iron grate, under which there is a convenient and removable ash pan for easy maintenance clean.
- 14. Inspection door** - modernized mechanism for opening the lower door, changing from a magnetic mechanism to a latch with a roller and spring. The spring integrated into the latch allows you to open the front by pressing.
- 15. Freedom of installation** - possibility to install the exhaust outlet both from the top and the back of the device. Comes with a masking cap that allows flush installation with the top plate.
- 16. Top plate** made of 5mm thick steel



ACCUMULATION

WATER TURBODYMIUM AND ACCUMULATION DISCS AS AN ADDITIONAL OPTION



BJORN



BJORN W



FURTHER FINISH VERSIONS



WATER TURBODYMIUM



3 CAST IRON OR CONCRETE ACCUMULATION DISKS



PRO Line Stoves

TORA

TORA stoves are a combination of elegance and modernity, ideal for homes that value both heating efficiency and unique design. They come in three sizes and different finishes - in quartz sintering and lacobel glass. As a result, every customer will find the right model for themselves.

Corner doors equipped with decorative blackened glazing guarantee a perfect view of the fire. In turn, technical solutions, such as a double deflector system and lining the hearth with Termotec material, optimize the combustion process and increase the energy efficiency of the device.



Scan the code
to find out more



Heating power range: **5 - 11 kW**

Heating efficiency: **78%**

PRO Line Stoves

TORA

Version / glazing:

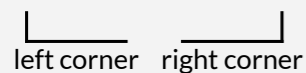

Termotec lining:

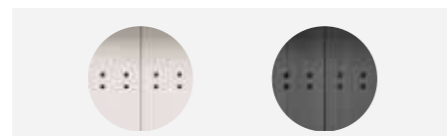

- 01. Resistant paint** - fireplace insert covered with a specially designed paint blend, with increased scratch resistance and characterized by a uniform and smooth texture, heat-resistant paint, does not emit odor.
- 02. Steel doors** made of closed profile, stable and resistant to stress.
- 03. Fireplace glass** - top-class heat-resistant ceramics from the renowned Schott brand. It is certified for quality and safety.

- 04. Clean glass system** - the use of an air curtain allows you to keep the glass clean.
- 05. Decorative GLASS** gives modernity and elegance, optically enlarges the front of the insert and guarantees a perfect view of the fire.
- 06. Railing** - a simple and aesthetically pleasing handle in the form of a slender rail, provides a comfortable grip along its length.
- 07. Door closing as standard** - a mechanism implemented by a tension spring that generates the force needed to return the door to the closed position.
- 08. Feet** - adjustable leveling feet with plastic base.
- 09. Air supply from the outside** - air intake implemented by means of an external spigot (with the possibility of connection from the back as well as from the bottom).
- 10. Deflector** - made of TERMOTEC, which extends the path of the flue gas, lowers its temperature and causes better afterburning, which gives the possibility of recovering more heat.
- 11. TERMOTEC lining** - a material that ensures efficient combustion, accumulates heat and increases the temperature in the hearth. It gives the fireplace an elegant appearance. It comes in white or black.
- 12. Ventilation of the combustion chamber** - an elaborate triple air supply system inside the fireplace, which allows for precise control of combustion.
- 13. Deepened combustion chamber** - a specially profiled, deepened bottom plate that provides comfort when loading wood. It prevents ash from falling out.
- 14. Ash pan and grate** - durable cast iron grate, under which there is a convenient and removable ash pan for easy maintenance clean.
- 15. Inspection door** - modernized mechanism for opening the lower door, changing from a magnetic mechanism to a latch with a roller and spring. The spring integrated into the latch allows you to open the front by pressing.
- 16. Top plate** made of 5mm thick steel
- 17. Freedom of installation** - possibility to install the exhaust outlet both from the top and the back of the device. Comes with a masking cap that allows flush installation with the top plate.



Meets Ecodesign requirements



Designed for recuperation



Compliance with the standard BImSchV2



ACCUMULATION



FINISH MATERIAL

LACOBEL



Black



White

SINTER

STANDARD



Nero Assoluto

SINTERS

TO ORDER



Oxide Moro

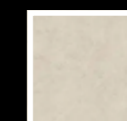

Fokos Sale



Petra Di Savola
Girgia

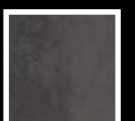

Petra Di Savola
Antracite

PRO Line Stoves

REN

The REN stove is an option for those who appreciate style, elegance and top quality. The device provides a unique view of the fire, which is guaranteed by, among other things, a clean glass system and an elegant finish with decorative Glass glass. In turn, the solutions used, such as the double deflector, the flue outlet shutter and the Termotec furnace lining, guarantee efficient combustion and optimal use of energy.

The stove is covered with a special coating with increased scratch resistance and a uniform, smooth structure. In turn, adjustable feet, an enlarged opening in the base of the stove and flexible mounting options for the chimney connection facilitate installation.



Scan the code
to find out more



Heating power range: **4.3 - 10.3 kW**

Heating efficiency: **80.2%**

PRO Line Stoves

REN

Version / glazing:

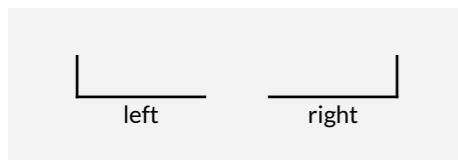

Termotec lining:

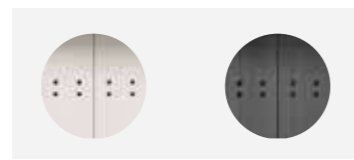

- 01. Resistant paint** - fireplace insert covered with a specially designed paint blend, with increased scratch resistance and characterized by a uniform and smooth texture, heat-resistant paint, does not emit odor.
- 02. Steel doors** made of closed profile, stable and resistant to stress.
- 03. Fireplace glass** - top-class heat-resistant ceramics from the renowned Schott brand. It is certified for quality and safety.
- 04. Clean glass system** - the use of an air curtain allows you to keep the glass clean.
- 05. Decorative GLASS** gives modernity and elegance, optically enlarges the front of the insert and guarantees a perfect view of the fire.
- 06. Railing** - a simple and aesthetically pleasing handle in the form of a slender rail, provides a comfortable grip along its length.
- 07. Feet** - adjustable leveling feet with plastic base.
- 08. Air supply from the outside** - air intake implemented by means of an external spigot (with the possibility of connection from the back as well as from the bottom).
- 09. Deflector** - the device is equipped with two deflectors (thermotec/steel) that provide a natural convection channel for the flue gas flow, intensifying heat exchange.
- 10. TERMOTEC lining** - a material that ensures efficient combustion, accumulates heat and increases the temperature in the hearth. It gives the fireplace an elegant appearance. It comes in white or black.
- 11. Ventilation of the combustion chamber** - an elaborate triple air supply system inside the fireplace, which allows for precise control of combustion.
- 12. Deepened combustion chamber** - a specially profiled, deepened bottom plate that provides comfort when loading wood. It prevents ash from falling out.
- 13. Ash pan and grate** - durable cast iron grate, under which there is a convenient and removable ash pan for easy maintenance clean.
- 14. Inspection door** - are equipped with a push-to-open mechanism that allows opening by gently pressing, without the use of traditional handles or grips. The door covers the air intake connection and the adjustment screws of the leveling feet.
- 15. Freedom of installation** - possibility to install the exhaust outlet both from the top and the back of the device. Comes with a masking cap that allows flush installation with the top plate.
- 16. Top plate** made of 5mm thick steel

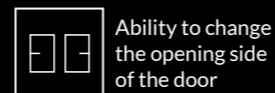
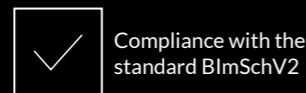
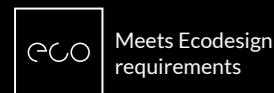

ACCUMULATION

WATER TURBODIUM AND ACCUMULATION DISCS AS AN ADDITIONAL OPTION



REN S
REN S L/P



REN M
REN M L/P



REN L
REN L L/P



REN L - WATER TURBODIUM



REN L - 5 ACCUMULATION DISCS



REN M - 2 ACCUMULATION DISCS

PRO Line Stoves

INGA

INGA stove is distinguished by three-sided glazing, which provides a unique view of the burning fire. Decorative GLASS glass optically enlarges the hearth and adds elegance to the interior. The steel door made of a closed profile is extremely resistant to stress and high temperatures, and guarantees durability and safety.

When designing the INGA stove, we also thought about installers - adjustable legs allow the device to be easily leveled, and the possibility of installing the flue outlet both from the top and from the back allows the device to be installed in any room.

This combination of functionality and unique design makes the INGA stove an ideal solution for those who appreciate both quality, as well as unique style.



Scan the code
to find out more



Heating power range: **5 - 11 kW**

Heating efficiency: **79.6%**

PRO Line Stoves

INGA



Version / glazing:



Termotec lining:

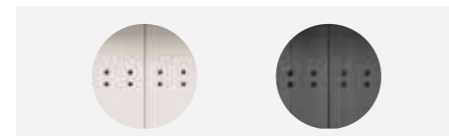

Meets Ecodesign requirements



Designed for recuperation



Compliance with the standard BImSchV2



- 01. Resistant paint** - fireplace insert covered with a specially designed paint blend, with increased scratch resistance and characterized by a uniform and smooth texture, heat-resistant paint, does not emit odor.
- 02. Steel doors** made of closed profile, stable and resistant to stress.
- 03. Fireplace glass** - top-class heat-resistant ceramics from the renowned Schott brand. It is certified for quality and safety.
- 04. Double glazing system** - has a positive effect on heating efficiency (longer and more even heat emission into the room) and cleanliness of the glazing and the interior of the combustion chamber.
- 05. Clean glass system** - the use of an air curtain allows you to keep the glass clean.
- 06. Decorative GLASS** gives modernity and elegance, optically enlarges the front of the insert and guarantees a perfect view of the fire.
- 07. Feet** - adjustable leveling feet with plastic base.
- 08. Air supply from the outside** - air intake implemented by means of an external spigot (with the possibility of connection from the back as well as from the bottom).
- 09. Deflector** - made of TERMOTEC, which extends the path of the flue gas, lowers its temperature and causes better afterburning, which gives the possibility of recovering more heat.
- 10. TERMOTEC lining** - a material that ensures efficient combustion, accumulates heat and increases the temperature in the hearth. It gives the fireplace an elegant appearance. It comes in white or black.
- 11. Ventilation of the combustion chamber** - an elaborate triple air supply system inside the fireplace, which allows for precise control of combustion.
- 12. Deepened combustion chamber** - a specially profiled, deepened bottom plate that provides comfort when loading wood. It prevents ash from falling out.
- 13. Ash pan and grate** - durable cast iron grate, under which there is a convenient and removable ash pan for easy maintenance clean.



PRO Line Stoves

KARI

KARI stove is a modern solution that combines the advantages of a built-in fireplace cassette with the practical aspects of having a spacious recess for wood. This type of stove is an ideal choice for people who value not only functionality and heating efficiency, but also aesthetics and practicality in everyday use. The external components of the KARI stove (housing, recess and top plate) are made of high-quality steel with a thickness of 5 mm. As a result, they not only effectively withstand high temperatures, but also guarantee the stability of the entire structure. In addition, the stove is covered with a specially designed paint mixture, with increased scratch resistance and characterized by a uniform and smooth structure.

KARI is a solution for those looking for a modern and efficient source of heat for their home - it is capable of heating up to 110 m² of space.



Scan the code
to find out more



Heating power range: **3.5 - 16.5 kW**

Heating efficiency: **84%**

PRO Line Stoves

KARI

Version / glazing:



Termotec lining:

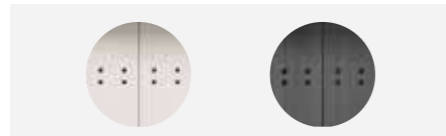

- 01. Resistant paint** - fireplace insert covered with a specially designed paint blend, with increased scratch resistance and characterized by a uniform and smooth texture, heat-resistant paint, does not emit odor.
- 02. Steel doors** made of closed profile, stable and resistant to stress.
- 03. Fireplace glass** - top-class heat-resistant ceramics from the renowned Schott brand. It is certified for quality and safety.
- 04. Clean glass system** - the use of an air curtain allows you to keep the glass clean.
- 05. Decorative GLASS** gives modernity and elegance, optically enlarges the front of the insert and guarantees a perfect view of the fire.
- 06. Perforated handle** - its special design means that it does not get excessively hot.
- 07. Feet** - adjustable leveling feet with double-screw mounting.
- 08. Air supply from the outside** - air intake implemented by means of an external spigot.
- 09. Removable steel deflector**, which extends the path of the flue gas, lowers its temperature and causes better afterburning, which gives the possibility of recovering more heat.
- 10. TERMOTEC lining** - a material that ensures efficient combustion, accumulates heat and increases the temperature in the hearth. It gives the fireplace an elegant appearance. It comes in white or black.
- 11. Ventilation of the combustion chamber** - an elaborate triple air supply system inside the fireplace, which allows for precise control of combustion.
- 12. Ash pan and grate** - durable cast iron grate, under which there is a convenient and removable ash pan for easy maintenance clean.
- 13. Wood bay** - is an excellent way to store and displaying the logs in the room. In addition to its practical function, it plays a decorative role, adding charm and character to the interior.
- 14. The external components of the KARI stove** (the body, the cavity and the top plate) are made of high-quality steel with a thickness of 5 mm. As a result, they not only effectively withstand high temperatures, but also guarantee the stability of the entire structure.



Meets Ecodesign requirements



Designed for recuperation



Compliance with the standard BImSchV2



KARI 70



KARI 80



KARI 95

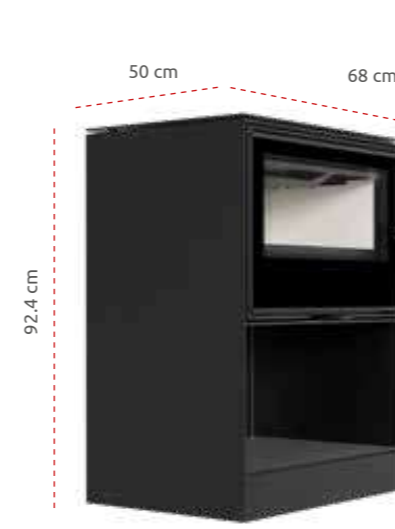

KARI 70 W



KARI 80 W



KARI 95 W

PRO Line Stoves

K11

The K11 cast iron stove, despite its small size, presents great performance and is capable of heating up to 90 m². This compact goat combines traditional design with modern combustion technologies, offering users not only an efficient but also an ecological heat source. It meets the requirements of Ecodesign, the German BlmschV II standard and Flamme Verte standards. It cooperates with recuperation.

The side walls of the combustion chamber are additionally lined with TERMOTEC material, which accumulates heat, increasing the efficiency of combustion and prolonging the maintenance of the temperature in the stove. A cast iron grate, divided into two parts, intuitive regulation of primary and secondary air, a cold handle system, a pull-out ash drawer and a hurdle to prevent wood from falling out - all this guarantees very easy use of the of the stove.



Scan the code
to find out more





Heating power range: **3 - 9 kW** Heating efficiency: **76.9 %**

PRO Line Stoves

K11

Version / glazing:



Termotec lining:

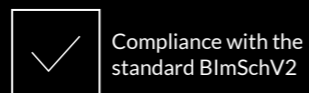
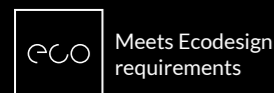
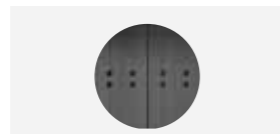

- 01. Heat-resistant ceramic** with impressive high heat, chemical and mechanical resistance, as well as near-zero thermal expansion. The ceramic used has a thickness of 4mm and a heat resistance of up to 600°C.
- 02. A cast iron deflector** that provides a natural convection channel for the flow of flue gases, intensifying heat exchange. This increases combustion efficiency and guarantees better energy utilization.
- 03. Clean glass system** - the use of an air curtain allows you to keep the glass clean.
- 04. Adjustment of the air curtain** - Access to the adjustment element possible when the oven door is opened.
- 05. Ventilation of the combustion chamber** - an elaborate triple air supply system inside the fireplace, which allows for precise control of combustion.
- 06. Independent air intake dampers** in the form of a flat sliding element sealed with a Teflon washer for tightness and quiet operation.
- 07. TERMOTEC lining** - The side walls of the combustion chamber lined with a material that ensures efficient combustion, accumulates heat and increases the temperature in the combustion chamber. Black Termotec as standard.
- 08. Removable ash pan** in the form of an independent steel drawer in which the by-product of biomass combustion is collected.
- 09. Two-piece grate** - helps distribute air evenly throughout the base of the stove reducing the possibility of localized surface overheating.
- 10. Cold handle system** - allows you to remove the handle so that the so that the handle remains cool enough for you to so that the handle remains cool enough to safely grasp and open or close the stove door.
- 11. Air supply from the outside** - air intake implemented by means of an external spigot.



ACCESSORIES

AND PERSONALIZATION

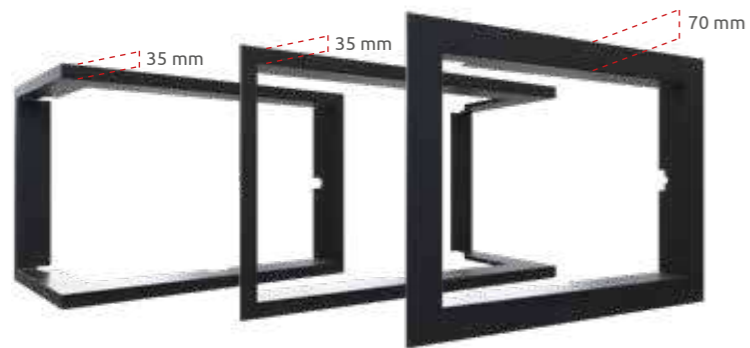

FRAMES

Frames available with press-fastening and magnets, for all glazing.

Widths:

- 35 mm
- 70 mm

TERMOTEC

A fireplace lining that accumulates heat and increases the temperature in the hearth. It gives the fireplace an elegant look. Available in white or black. **Optional black lining available for all models.**

STOVE BASES

Glass bases and black steel bases. Steel ones currently available in nine designs, glass ones in two.

Glass bases:

- PS/ATHINA - 90x100cm
- PS/MADRIT - 85x100cm

Steel bases:

- PS/W1 - 100x100cm
- PS/W2 - 100x80cm
- PS/W3 - 100x100cm
- PS/W4 - 100x100cm
- PS/W5 - 80x90cm
- PS/W6 - 80x100cm
- PS/W7 - 40x100cm
- PS/W8 - 80x100cm
- PS/W9 - 80x80cm



CONCRETE DISKS

Available sets of 2, 3 or 5 discs depending on the stove model.



CAST IRON DISCS

Available sets of 2, 3 or 5 discs depending on the stove model.



WATER TURBODIMUM

The size depends on the stove model.











Cast iron and concrete accumulation disks are components used to recover chimney loss and store heat, which can then be gradually released into the environment. One disc consists of two semicircles.













Turbodimur is a chimney cap designed to be mounted on the outlet of the flue gas from the fireplace. The water turbodimur transfers heat to the domestic water or through the central heating system to radiators in the living areas.



FIREPLACES

SPECIFICATIONS

											
LUCY/12	12	5.0 - 15.0	80	0.1	15	105.40	270	200	A	✓	✓
LUCY/12/SLIM	8	3.0 - 10.0	83	0.09	9	109.30	180	160	A+	✓	✓
LUCY/14	14	6.0 - 17.0	81	0.1	18	106.71	265	200	A	✓	✓
LUCY/14/SLIM	10	4.0 - 12.0	85	0.09	19	111.90	172	160	A+	✓	✓
LUCY/15	15	6.5 - 18.5	81	0.1	19	106.71	263	200	A	✓	✓
LUCY/16	16	7.0 - 20.0	81	0.09	20	106.71	260	200	A	✓	✓
FLOKI S	8	3.5 - 11.0	79.7	0.08	19	106.71	270	160	A	✓	✓
FLOKI M	10	4.5 - 13.5	83	0.09	28	110.4	240	200	A+	✓	✓
FLOKI L	12	10.0 - 14.0	85	0.1	17	106	260	200	A+	✓	✓
MBM	10	4.5-12.5	81	0.1	28	106.71	235	200	A	✓	✓
MBZ	13	6.0 - 16.0	81	0.09	27	106.71	235	200	A	✓	✓
MBO	15	7.0 - 19.0	83	0.09	30	109.32	240	200	A+	✓	✓
MBA	17	8.0 - 21.0	80	0.09	35	105.40	250	200	A	✓	✓
MBN	8	4.0 - 11.0	80	0.1	21	105.40	255	200	A	✓	✓
MBN 680	10	5.0 - 12.0	81	0.1	30	108.50	261	200	A+	✓	✓
MB 100 G	14	6.0 - 17.0	82	0.1	27	108.01	220	200	A	✓	✓
MB 120 G	22	10.0 - 27.0	80	0.1	11	105.40	240	200	A	✓	✓

												
✓	166	35	610x460	≥900	≥700	✓	✓	✓	✓			
✓	155	35	610x482	≥700	≥500	✓	✓	✓				
✓	182	40	760x460	≥900	≥700	✓	✓	✓	✓			
✓	180	40	760x480	≥700	≥500	✓	✓	✓				
✓	205	40	760x590	≥900	≥700	✓						
✓	213	50	905x411	≥1000	≥800	✓			✓			
✓	136	40	601x422	≥700	≥500	✓	✓	✓				
✓	160	50	732x419	≥700	≥500	✓	✓	✓				
✓	169	50	832x419	≥700	≥500	✓	✓	✓				
✓	161	50	535x413	≥700	≥500	✓	✓	✓		✓	✓	✓
✓	185	50	584x474	≥900	≥700	✓	✓	✓		✓	✓	✓
✓	214	50	686x476	≥900	≥700	✓	✓	✓		✓	✓	✓
✓	222	50	686x536	≥1000	≥800	✓	✓	✓		✓	✓	✓
✓	159	30	457x474	≥700	≥500	✓	✓	✓		✓		
✓	159	30	402x626	≥700	≥500	✓	✓	✓				
✓	327	50	955x314	≥900	≥700					✓		
✓	396	50	1155x384	≥1000	≥800					✓		

NBC 7 680/280	7	3.0 - 9.0	83	0.1	29	105.40	199	160	A	✓	✓
NBC 8 500/500	8	3.5 - 10.0	83	0.09	38	105.40	198	200	A	✓	✓
NBC 9 600/400	9	4.0 - 11.0	84	0.09	22	105.40	192	200	A	✓	✓
NBC 10 800/400	10	5.0 - 13.0	83	0.06	27	106.71	191	200	A	✓	✓
NBC 15 1000/400	15	7 - 21	78	0.1	24	103	270	200	A	✓	✓
NBU 11 500/700	11	4.5 - 14.0	83	0.09	17	109.30	180	200	A+	✓	✓
NADIA/8	7	3.0 - 9.0	80	0.1	38	105.40	245	200	A	✓	✓
NADIA/9	9	5.0 - 11.0	80	0.1	35	105.40	251	200	A	✓	✓
NADIA/10	10	5.0 - 12.5	80	0.1	32	105.40	255	200	A	✓	✓
NADIA/12	12	8.0 - 16.0	80	0.08	36	105.40	245	200	A	✓	✓
NADIA/13	13	6.0 - 16.5	81	0.08	37	106.71	240	200	A	✓	✓
NADIA/14	14	6.5 - 17.0	80	0.09	37	105.40	245	200	A	✓	✓
VN 610/430	9	3.5 - 11.0	81	0.09	23	106.71	285	200	A	✓	
VN 480/480	8	3.5 - 10.0	84	0.1	33	111.01	285	200	A+	✓	
VN 700/480	12	5.0 - 15.0	82	0.1	27	108	240	200	A+	✓	
VN 810/410	14	6.0 - 17.0	82	0.09	13	108	245	200	A+	✓	
ZOSIA	12	6.0 - 15.5	83	0.10	22	109.32	209	200	A+	✓	✓
ZOSIA DECO	12	6.0 - 15.5	83	0.10	22	109.32	209	200	A+	✓	✓

				$\geq m^2$	$\geq m^2$												
✓	188	40	680x339	≥ 700	≥ 500												✓
✓	238	40	494x464	≥ 700	≥ 500												✓
✓	235	30	594x464	≥ 700	≥ 500												✓
✓	275	30	794x464	≥ 700	≥ 500												✓
✓	-	-	994x464	≥ 700	≥ 500												✓
✓	299	50	483x509	≥ 900	≥ 700												✓
✓	106	30	410x482	≥ 700	≥ 500	✓											
✓	128	32	407x647	≥ 700	≥ 500	✓											
✓	128	35	610x460	≥ 900	≥ 700	✓								✓			
✓	149	40	757x460	≥ 900	≥ 700	✓								✓			
✓	178	40	760x612	≥ 900	≥ 700	✓								✓			
✓	173	50	902x411	≥ 900	≥ 700	✓								✓	✓	✓	
✓	204	40	582x430	≥ 700	≥ 500									✓	✓		
✓	198	30	452x452	≥ 700	≥ 500									✓	✓		
✓	250	40	672x490	≥ 900	≥ 700									✓	✓		
✓	261	40	782x490	≥ 900	≥ 700									✓	✓		
✓	194	50	639x478	≥ 900	≥ 700	✓											
✓	184	50	639x478	≥ 900	≥ 700	✓											

WATER BOILER FIREPLACES

SPECIFICATIONS

LUCY PW 12	12	5.0 - 15.0	7	82	0.10	24	108.01	210	35	200
LUCY PW 16	16	7.0 - 19.0	10	84	0.09	25	110.62	200	39	200
LUCY PW 20	20	9.0 - 24.0	13	82	0.09	22	108.01	230	45.5	200
MBM PW 10	12	5.0 - 14.0	7	85	0.10	27	111.9	185	26.5	180
MBZ PW 13	13	6.0 - 16.0	7	81	0.10	32	106.71	230	35	200
MBO PW 15	15	6.0 - 18.0	8	83	0.10	7	109.30	210	42	200
MBA PW 17	17	9.0 - 19.5	9	86	0.09	8	113.20	201	47	200
Nadia PW 10	12	5.0 - 13.5	4.7	82	0.10	37	108.01	225	32	200
ZOSIA PW DECO 14	14	5.5 - 16.5	7.5	85.7	0.10	20	114	210	40.5	200

2	A+	✓	✓	✓	215	50	607x477	✓	✓				
2	A+	✓	✓	✓	257	50	757x477	✓	✓				
2	A+	✓	✓	✓	293	50	902x428	✓	✓	✓	✓		
2	A+	✓	✓	✓	232	50	535x396	✓		✓	✓		✓
2	A	✓	✓	✓	262	50	584x458	✓		✓	✓		✓
2	A+	✓	✓	✓	306	50	686x458	✓		✓	✓		✓
2	A+	✓	✓	✓	314.5	50	686-518	✓		✓	✓		✓
2	A	✓	✓	✓	190	35	607x477	✓					
2	A+		✓	✓	200	50	639x478	✓					









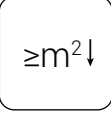

STOVES



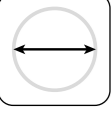
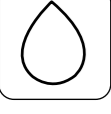
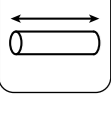
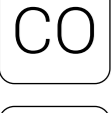

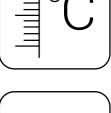

SPECIFICATIONS

TOFA	8	6 - 10	79	0.10	30	105.6	280	150	A		✓	✓
AB ENYO R, R/W	5.5	2.5 - 8.5	80.5	0.10	21	107.7	297	150	A	✓	✓	✓
TORA S, M, L	8	5 - 11	78	0.10	19	103	300	150	A		✓	✓
RUNA	8	6 - 10	80	0.10	30	107	280	150	A		✓	✓
REN S, M, L	7.3	4.3 - 10.3	80.2	0.04	33	106.3	250	150	A	✓	✓	✓
INGA	8	5 - 11	79.6	0.07	28	105	300	150	A		✓	✓
ERIK / ERIK W	5.5	2.5 - 8.5	80.5	0.077	37	106.7	297	150	A	✓	✓	✓
BJORN / BJORN W	8	5 - 11	78.4	0.117	40	103.7	255	150	A	✓		✓
SVEN	7	4 - 10	75.7	0.071	24	99.8	235	150	A	✓	✓	✓
KARI 70 / KARI 70 W	8	3.5 - 10.0	84	0.09	14	110.62	165	150	A+	✓	✓	✓
KARI 80 / KARI 80 W	12	6 - 16	75	0.10	34	113	320	180	A+	✓	✓	✓
KARI 95 / KARI 95 W	14	6.0 - 16.5	83	0.10	37	109.32	195	200	A+	✓	✓	✓
K11	6	3 - 9	76.9	0.096	31	101.5	265	150	A	✓	✓	✓

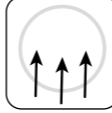
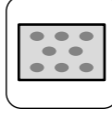
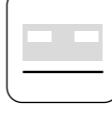

✓	172	25	428x394		✓				✓	✓	2
✓	124 / 155	25	271x386	✓					✓	✓	1
✓	145 / 183 / 228	25	344x585			✓	✓		✓	✓	2
✓	180.3	25	458x670		✓				✓	✓	2
✓	159	25	432x702			✓	✓		✓	✓	2
✓	203	25	535x574. 350x470					✓	✓	✓	1
✓	113.25 / 247.16	25	293x430		✓				✓	✓	1
✓	163 / 187	50	640x580		✓				✓	✓	2
✓	139.74	25	317x400		✓				✓	✓	2
✓	176.91 / 226.28	30	617x406	✓					✓	✓	1
✓	198.92 / 220	50	707x500	✓					✓	✓	1
✓	253.22 / 328.12	50	887x504	✓					✓	✓	1
✓	133.75	25	328x292	✓					✓	✓	-

DESIGNATIONS IN THE TABLE

-  Min outlet grids active field (cm2)
-  Min inlet grids active field (cm2)
-  Rated output (kW)
-  Heating power range (kW)
-  Heating efficiency (%)
-  Flue outlet diameter (mm)
-  Water capacity (l)
-  Max length of logs (cm)
-  CO emissions (at 13% O₂) ≤ given in %
-  Dust emission (mg/Nm³)
-  Exhaust gas temperature (°C)
-  Energy class
-  Max working pressure (bar)
-  Energy efficiency index (EEI)

-  Air intake - a spigot mounted to the fireplace insert, the purpose of which is to supply fresh air to the fireplace from outside the building
-  Movable grate so you can easily sweep out the ashes
-  Deflector / number of deflectors to extend the combustion path
-  Meets BlmSchV2 criteria
-  Meets Ecodesign criteria
-  Meets FlammeVerte criteria
-  Suitable for homes with recuperation systems
-  Glazing dimensions

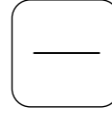
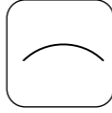
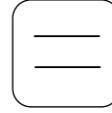
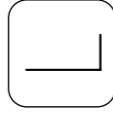
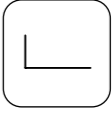
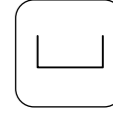
GLAZING

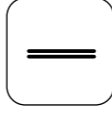
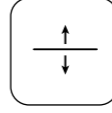
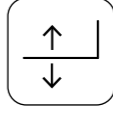
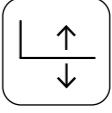
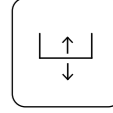
- | | | | | | |
|---|---|---|---|---|---|
|  |  |  |  |  |  |
| Front facing | Curved | Tunnel | Right corner | Left corner | Three panes |
|  |  |  |  |  |  |
| Bent glass | Double glass | Front lift-up | Right corner lift-up | Left corner lift-up | Three panes lift-up |



Kratki.pl Marek Bal
Gombrowicza 4, Wsola, 26-660 Jedlińsk, Poland
www.kratki.com

www.facebook.com/kratkien
www.youtube.com/kratkipl
www.instagram.com/kratki.pl