





K5 S



Thor View



K8 T

Gwarantujemy najwyższą jakość produkcji, czego dowodem są zdobyte certyfikaty i nagrody.

We guarantee the highest production quality, as evidenced by the obtained certificates and awards.

Unsere Zertifikate und Auszeichnungen garantieren höchste Qualität der Produktion.

Мы гарантируем наивысшее качество продукта, доказательствами этого являются наши награды и сертификаты.



Nasza firma istnieje na rynku polskim od 1998 roku. Dziś jesteśmy znanym i cenionym producentem kominków, kratek oraz akcesoriów kominkowych. Dzięki dynamicznemu rozwojowi, szerokiej gamie i trwałości naszych produktów, szybko znaleźliśmy się w czołówce firm kominkowych w Europie. Ciągłe inwestycje w wykwalifikowaną kadrę oraz nowoczesne technologie przełożyły się na najwyższą jakość naszych produktów.

Nie ustajemy w dążeniach do perfekcji, wierząc, że polskie produkty mogą śmiało konkurować z uznanymi na świecie zachodnimi markami, czego dowodem są zdobyte przez nas certyfikaty i nagrody.

„Our company has been present on the Polish market since 1998. Today we are a well-known and respected manufacturer of fireplaces, grilles and fireplace accessories. Due to the dynamic development, wide range and durability of our products, we are a leading the fireplace companies in Europe. Continuous investments in qualified staff and modern technologies had a direct influence on the highest quality of our products.

We do not cease our pursuit of perfection, believing that Polish products can compete with well-known western brands, as evidenced by our certificates and awards.”

„Unsere Firma gibt es auf dem polnischen Markt seit 1998. Heute sind wir ein bekannter und begehrten Hersteller von Kaminen, Kamingittern und Zubehörteilen. Dank dynamischer Entwicklung, hoher Qualität und grosser Lebensdauer unserer Produkte befindet wir uns an der Spitze der Kaminfirmen in Europa. Kontinuierliche Investitionen in qualifiziertes Personal und moderne Technologien in die höchste Qualität unserer Produkte übersetzen.

Wir streben ständig nach Perfektion, zu glauben, dass polnische Produkte leicht mit etablierten westlichen Marken in der Welt konkurrieren können, von unseren erworbenen Zertifizierungen und Auszeichnungen belegt.”

„Мы находимся на польском рынке с 1998 года. На сегодня мы являемся известным и уважаемым производителем топок, печей, каминных решеток, а также каминных аксессуаров. Благодаря динамичному развитию, широкой гамме и долговечности наших продуктов мы быстро оказались среди европейских лидеров в отрасли производства топок. Постоянные инвестиции в высококвалифицированных специалистов и в новые технологии перенесли на наивысшее качество наших продуктов. Мы не прекращаем стремиться к совершенству, полагая, что польские продукты могут смело конкурировать с уважаемыми в мире западными брендами, свидетельством чего являются полученные нами сертификаты и награды”





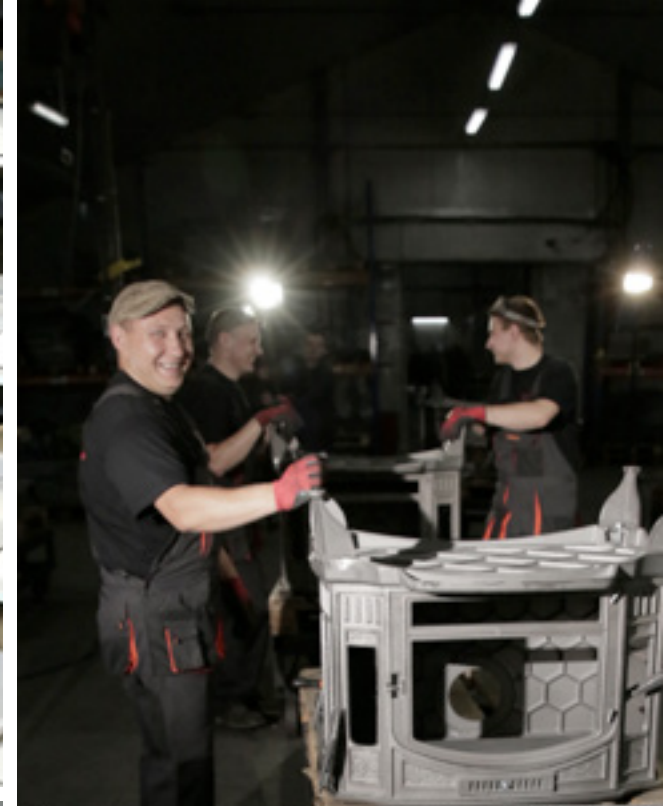

Podstawą sukcesu firmy Kratki.pl jest oferowanie produktów i usług o doskonałej jakości.

PEWNI JAKOŚCI to hasło, które od początku powstania firmy Kratki.pl przyświeca naszej działalności. Dbałość o najwyższy poziom produktów oraz świadczonych usług są podstawowym filarem naszej marki. Dowodem spełniania światowych standardów jest uzyskanie certyfikatu ISO 9001:2008 oraz nagród, które potwierdzają jakość oferty firmy Kratki.pl.

Jako firma ponosimy pełną odpowiedzialność za klasę wyprodukowanych wkładów kominkowych i pieców wolnostojących. Status lidera na rynku krajowym osiągnęliśmy nie tylko dzięki bogatej ofercie, ale przede wszystkim wysokiemu poziomowi naszych produktów.

Nasze wkłady kominkowe spełniają najsurowsze wymagania środowiskowe. Oznacza to że są one zgodne dyrektywą unijną, zwaną potocznie ekoprojektem.

The basis of Kratki.pl's success is to offer products and services of excellent quality.

CONFIDENCE OF QUALITY is the slogan which, from the very beginning of Kratki.pl company, has been leading our business. The care of the highest level of products and services is the basic pillar of our brand. The certificate of ISO 9001: 2008 and the awards that confirm the quality of the Kratki.pl offer prove fulfilment of world standards. As a company we take full responsibility for the quality of fireplace inserts and freestanding stoves. Our market leader status was achieved not only due to the wide range of offer, but also because of the high level of our products.

Our fireplace inserts fulfil the strictest environmental requirements. This means that they fully comply with the EU directive, commonly known as ecodesign.

Die Basis für den Erfolg des Unternehmens Kratki.pl ist es, Produkte und Dienstleistungen von hervorragender Qualität anbieten zu können.

Gewissheit in der Qualität ist ein Kennwort, das seit der Gründung des Unternehmens geführt Kratki.pl unser Geschäft. Aufmerksamkeit auf das höchste Niveau von Produkten und Dienstleistungen, die wir bieten ist eine wesentliche Säule unserer Marke. Der Nachweis der Einhaltung der internationalen Normen ISO 9001: 2008 und die Auszeichnungen, die die Qualität des Angebots Kratki.pl des Unternehmens bestätigen.

Als Unternehmen übernehmen die volle Verantwortung für die Klasse der hergestellten Kamineinsätze und freistehende Öfen. Der Status des Führers auf dem Inlandmarkt erzielte nicht nur durch das reichhaltige Angebot, vor allem aber das hohe Niveau unserer Produkte.

Die Basis für den Erfolg des Unternehmens Kratki.pl ist es, Produkte und Dienstleistungen von hervorragender Qualität anbieten zu können.

Основой успеха компании Kratki.pl является портфель продуктов и услуг великолепного качества.

УВЕРЕНЫ В КАЧЕСТВЕ это слоган, который сопутствует компании Kratki.pl от начала нашей деятельности. Уход за наивысшим уровнем качества продуктов, а также предоставляемых услуг является базовым столпом нашего бренда. Доказательством выполнения мировых стандартов является получение сертификата ISO 9001:2008, а также наград, которые подтверждают качество портфеля продукции компании Kratki.pl. Как компания мы несем полную ответственность за класс произведенных каминных топок и отдельностоящих печей. Статуса лидера нашего внутреннего рынка мы достигли не только благодаря нашему широкому портфелю продукции, а прежде всего из-за высокого уровня наших продуктов.

Наши каминные топки соответствуют самым жестким экологическим требованиям. А это значит что они соответствуют директиве Европейского Союза, котороуназываю экoproектом



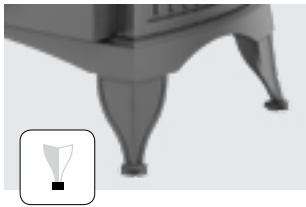

Nóżki ozdobne  
Decorative base feet  
Verzierte Füße  
Декоративные ножки

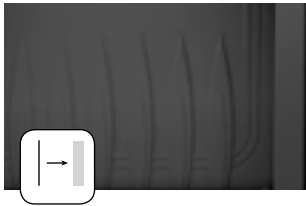

Ozdobna płyta tylna  
Decorative back plate  
Dekorative hintere Platte  
Декоративная задняя плита



Glass system - zewnętrzna szyba dekoracyjna, która nadaje kominkowi nowoczesny wygląd, optycznie powiększa front wkładu  
System glass - external decorative glass, which gives a fireplace modern look  
Glass-System - ist eine dekorative Außenscheibe, die dem Kamineinsatz ein modernes Design verleiht  
Двойное стекло - внешнее декоративное стекло, которое придает камину современный вид

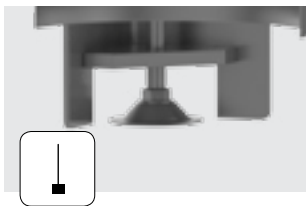

Regulowane nóżki ułatwiają wypoziomowanie wkładu  
Adjustable legs for leveling a fireplace  
Regulierbare Füße erleichtern das richtige Aufstellen des Kamineinsatzes  
регулируемые ножки, которые облегчают выравнивание топки

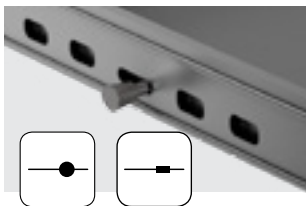

Regulacja dopływu powietrza pierwotnego do spalania  
Regulation of air supply for combustion  
Regulieren des Luftstroms durch die Aschenschublade  
Регулирование притока воздуха через вынимаемый пеплосборник

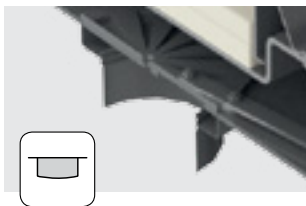

Dolot powietrza - króciec montowany do wkładu kominkowego, który ma na celu doprowadzenie świeżego powietrza do paleniska z zewnątrz budynku - dodatkowa opcja

External air inlet - special connector mounted in fireplace insert, which provides fresh air directly from outside - additional option

Externluftzufuhr - spezieller Stutzen, der am Kamineinsatz eingebaut wird, um frische Luft von außen für den Verbrennungsprozess zuzuführen - zusätzliche Option

Приток воздуха - Устройство для подвода воздуха в камеру сгорания - дополнительный выбор

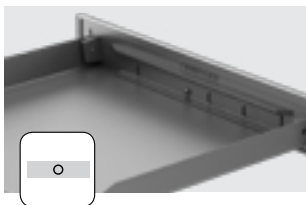

Szuflada/pojemnik na popiół, gdzie gromadzą się pozostałości po spalonym drewnie

Ash drawer/container where remains burnt wood

Aschenschublade in derer sich der Rest des verbrannten Holzes sammelt

Ящик/контейнер для пепла - здесь собираются остатки дров



Duża komora spalania wyłożona Acumotte (system otworów w ścianie tylnej odpowiada za napowietrzenie komory spalania)

Large combustion chamber - lined with Acumotte (system of holes in the back wall is in charge of the aeration of the combustion chamber)

Die Brennkammer ist mit Acumotte ausgelegt – dieses Material verbessert die Arbeitsparameter des Heizeinsatzes

Большая камера сгорания выложенная акумотте



Możliwość zamieszczenia wylotu spalin na górze i z tyłu (oprócz modelu K8 tunel)

Possibility to mount the exhaust outlet at the top and back (except model K8 tunnel)

Rohranschluss von oben und von hinten (ausser des Modell Koza K8)

Выпуск газов-возможность инсталляции из верха и в задней части печек (кроме печки K8 двухсторонной)



Ruchomy ruszt, dzięki któremu można łatwo wymieść popiół

Movable grate gives possibility of easily wipe away the ash

Beweglicher Rost hilft beim Reinigen

Движущиеся решетка благодаря которой Вы можете легко стереть пепел



AB | AB2 | THOR | FALCON  
ORBIT | JUNO







Thor



Falcon View







ABS K



ABS N K



|        |  |  |  |  |
|--------|---|---|---|---|
| AB     | 8   | 5.5 - 10.5  | 78  | 308x462   |
| AB2    | 10  | 6.0 - 12.0  | 80  | 555x462   |
| THOR   | 8   | 5.5 - 10.0  | 78  | 432x702   |
| FALCON | 9   | 6.0 - 11.0  | 78  | 352x462   |
| ORBIT  | 7   | 5.5 - 9.0   | 76  | 317x393   |
| JUNO   | 12  | 6.0 - 16.0  | 75  | 707x415   |



WK 440 | BLANKA | NADIA 8





Blanka kafel C





Nadia kafel B RYFEL

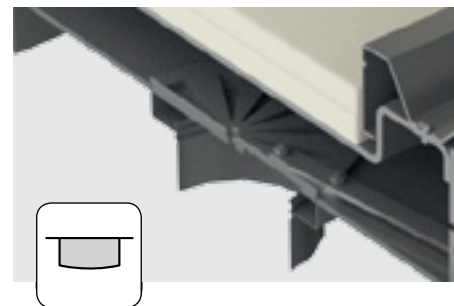
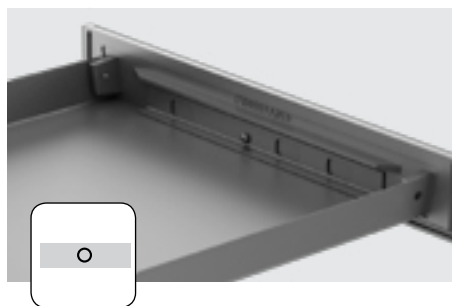

WK 440



|         | kW  | <kW<       |  |  |
|---------|-----|------------|---|---|
| WK 440  | 6,5 | 3.0 - 9.3  | 80  | 375x320   |
| BLANKA  | 8   | 7.5 - 11.0 | 78  | 384x448   |
| NADIA 8 | 7   | 3.0 - 9.0  | 80  | 407x477   |



K5 | K5 S | VEGA







VEGA







K5 S/N

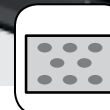
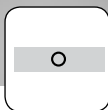
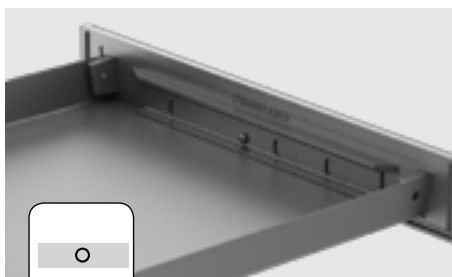

K5 S W



|      |  kW |  < kW |  |  |
|------|--|--|---|---|
| K5   | 7  | 5.5 - 9.0  | 76  | 396x303   |
| K5 S | 7  | 5.5 - 9.0  | 76  | 396x303   |
| VEGA | 6  | 3.5 - 8.0  | 78  | 380x493   |



K6 | K7 | K8 | K9 | K10





K9





K7



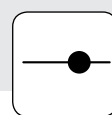
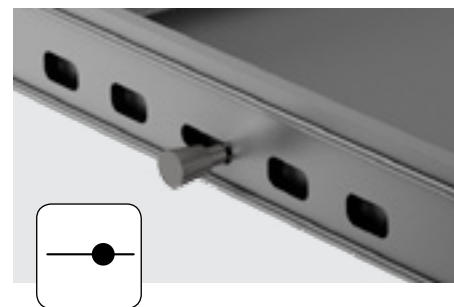
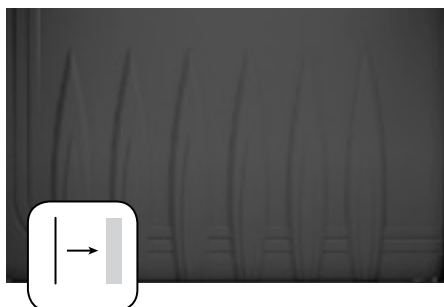
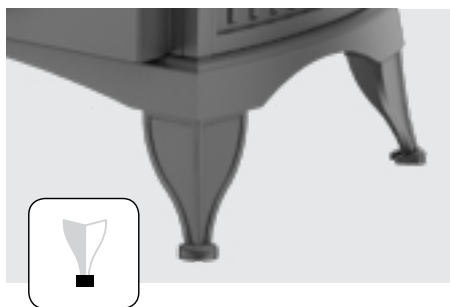











K8T





















|     | kW | <kW<       |  |  |
|-----|----|------------|---|---|
| K6  | 8  | 7.0 - 11.0 | 76  | 385x232   |
| K7  | 5  | 3.0 - 8.0  | 71  | 306x210   |
| K8  | 9  | 5.0 - 11.0 | 75  | 260x290   |
| K9  | 10 | 6.0 - 13.0 | 75  | 385x232   |
| K10 | 10 | 6.0 - 13.0 | 75  | 185x248   |



|         |  |  |  |  |  |  |  |  |  |  |  |  |  |  |
|---------|---|---|---|---|---|--|---|---|---|---|---|---|---|---|
| AB      | 8   | 5.5 - 10.5  | 78  | 0,08  | 39  | 275  | 150   | A   | ✓   |   | ✓   | 126   | 25  | 308x462   |
| AB2     | 10  | 6.0 - 12.0  | 80  | 0,09  | 15  | 280  | 150   | A   | ✓   | ✓   | ✓   | 150   | 50  | 555x462   |
| THOR    | 8   | 5.5 - 10.0  | 78  | 0,1   | 38  | 276  | 150   | A   | ✓   | ✓   | ✓   | 147   | 30  | 432x702   |
| FALCON  | 9   | 6.0 - 11.0  | 78  | 0,1   | -   | 285  | 150   | A   | ✓   | ✓   | ✓   | 132   | 30  | 352x462   |
| ORBIT   | 7   | 5.5 - 9.0   | 76  | 0,09  | 40  | 250  | 150   | A   | ✓   |   | ✓   | 99  | 25  | 317x393   |
| JUNO    | 12  | 6.0 - 16.0  | 75  | 0,1   | 34  | 320  | 150   | A   | ✓   |   | ✓   | 200   | 35  | 707x431   |
| WK 440  | 6,5   | 3.0 - 9.3   | 80  | 0,2   | 53  | 327  | 130   | A   |   |   | ✓   | 130   | 35  | 375x320   |
| BLANKA  | 8   | 7.5 - 11.0  | 78  | 0,1   | 36  | 285  | 160   | A   | ✓   |   | ✓   | 247   | 30  | 384x448   |
| NADIA 8 | 7   | 3.0 - 9.0   | 80  | 0,1   | 38  | 245  | 200   | A   | ✓   | ✓   | ✓   | 274   | 30  | 407x477   |
| K5 S    | 7   | 5.5 - 9.0   | 76  | 0,09  | 40  | 250  | 150   | A   | ✓   |   | ✓   | 110   | 25  | 396x303   |
| VEGA    | 6   | 3.5 - 8.0   | 78  | 0,1   | 21  | 242  | 130   | A   | ✓   |   | ✓   | 90  | 25  | 380x493   |
| K5      | 7   | 5.5 - 9.0   | 76  | 0,09  | 40  | 250  | 130   | A   | ✓   |   | ✓   | 118   | 25  | 396x303   |
| K6      | 8   | 7.0 - 11.0  | 76  | 0,3   | 88,9  | 360  | 130   | A   |   |   | ✓   | 119   | 35  | 385x232   |
| K7      | 5   | 3.0 - 8.0   | 71  | 0,3   | 187   | 340  | 130   | A   |   |   | ✓   | 75  | 30  | 306x210   |
| K8      | 9   | 5.0 - 11.0  | 75  | 0,19  | 23  | 385  | 130   | A   |   |   | ✓   | 126   | 35  | 260x290   |
| K9      | 10  | 6.0 - 13.0  | 75  | 0,29  | 14  | 379  | 130   | A   |   |   | ✓   | 165   | 35  | 385x232   |
| K10     | 10  | 6.0 - 13.0  | 75  | 0,19  | 19  | 334  | 130   | A   | ✓   | ✓   | ✓   | 109   | 35  | 185x248   |



|  |  |  |  |  |  |  |  |  |  |  |  |  |  |  |  |  |  |
|---|--|---|---|---|---|---|---|---|---|---|---|---|---|---|--|---|---|
| ✓   |  |   | ✓   |   | ✓   |   | ✓   | ✓   | ✓   |   | ✓   |   |   | ✓   | ✓  | ✓   | ✓   |
| ✓   | ✓  |   | ✓   |   | ✓   |   | ✓   | ✓   | ✓   |   | ✓   |   |   | ✓   | ✓  |   | ✓   |
| ✓   | ✓  |   | ✓   |   | ✓   |   | ✓   |   | ✓   |   | ✓   | ✓   | ✓   |   |  |   |   |
| ✓   |  |   | ✓   |   | ✓   |   | ✓   |   | ✓   |   | ✓   |   |   |   |  |   |   |
| ✓   |  |   | ✓   |   | ✓   |   | ✓   |   |   |   | ✓   |   |   |   |  |   |   |
| ✓   |  |   | ✓   |   | ✓   |   | ✓   |   | ✓   |   | ✓   |   | ✓   | ✓   |  |   | ✓   |
| ✓   |  |   | ✓   |   | ✓   |   | ✓   | ✓   |   |   | ✓   |   |   | ✓   |  |   | ✓   |
| ✓   |  |   | ✓   |   | ✓   |   | ✓   | ✓   | ✓   |   | ✓   |   |   |   |  |   |   |
| ✓   |  |   | ✓   | ✓   | ✓   |   | ✓   | ✓   | ✓   |   |   |   | ✓   |   |  |   |   |
| ✓   |  |   | ✓   |   | ✓   |   | ✓   |   |   |   | ✓   |   |   |   |  |   |   |
| ✓   |  |   | ✓   |   | ✓   |   | ✓   |   |   |   | ✓   |   | ✓   |   |  |   |   |
| ✓   |  |   | ✓   |   |   | ✓   |   |   |   |   | ✓   |   |   |   |  |   |   |
| ✓   |  |   | ✓   |   |   | ✓   |   |   |   |   | ✓   |   |   |   |  |   |   |
| ✓   |  |   | ✓   |   |   | ✓   |   |   |   |   | ✓   |   |   |   |  |   |   |
| ✓   |  | ✓   | ✓   |   |   | ✓   |   |   |   |   | ✓   |   |   |   |  |   |   |
| ✓   |  |   | ✓   |   |   | ✓   |   |   |   |   | ✓   |   |   |   |  |   |   |
| ✓   |  |   | ✓   |   |   | ✓   |   |   |   |   | ✓   |   |   |   |  |   |   |



Produkt ekologiczny. Spełnia kryteria Ekoprojektu.  
Ecological product. Complies with Ecodesign criteria.  
Öko-Produkt. Erfüllt die Kriterien der Ecodesign  
Экологичный продукт. Соответствует требованиям экопроекта

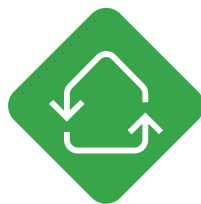



























Kominek idealny do domów z rekuperatorami  
Ideal for homes with heat recovery units  
Der ideale Kamin zu den Häusern mit den Abhitzeverwerter  
Идеально подходит для домов с энергосберегающими технологиями



Wkład kominkowy spełnia normy BlmSchV 2  
Fireplace insert meets BlmSchV 2 norms and regulations  
Kamineinsatz erfüllt die BlmSchV Stufe 2  
Каминная топка соответствует нормам BlmSchV 2



5 lat gwarancji  
5 years warranty  
5 Jahre Garantie  
5 лет гарантии

|   |  |   |  |   |   |
|---|--|---|--|---|---|
|    | <p>Moc nominalna<br/>Power rating (kW)<br/>Nominalleistung (kW)<br/>Мощность (кВт)</p>   |    | <p>Waga<br/>Weight (Kilo)<br/>Gewicht (Kilo)<br/>Вес (Kr)</p>  |  | <p>Dolot powietrza<br/>External air inlet<br/>Externluftzufuhr<br/>Приток воздуха</p>   |
|    | <p>Zakres mocy grzewczej (kW)<br/>Range of power rating (kW)<br/>Leistungsbereich (kW)<br/>Диапазон мощности нагрева (кВт)</p>   |    | <p>Długość polan (mm)<br/>Length of wood (mm)<br/>Holzscheitslänge (mm)<br/>Длина поленьев (мм)</p>  |  | <p>Ruchomy wylot spalin<br/>Movable exhaust outlet<br/>Rauhrohrausgang-Beweglich<br/>Подвижная труба вылета продуктов горения</p>             |
|    | <p>Sprawność cieplna (%)<br/>Efficiency (%)<br/>Wirkungsgrad (%)<br/>Тепловая мощность (%)</p>   |    | <p>Wymiary szyby<br/>Dimensions glass<br/>Masse Fenster<br/>Размер окна</p>  |  | <p>Ruszt<br/>Grate<br/>Rost<br/>Решетка</p>   |
|    | <p>CO - Emisja (przy 13% O2) ≤ podawana w %<br/>CO - Emission (with 13% O2) ≤ Given in percent<br/>CO - Emmission (bei 13% O2) ≤ angegeben in %<br/>CO - Эмиссия (при 13% O2) ≤ дано в процентах</p>                         |    | <p>Szyba prosta<br/>Front glass<br/>Glass gerade<br/>Простая</p>   |  | <p>Drzwi z pełnego profilu<br/>Door manufacured from full metal profile<br/>Tür aus dem vollen Profil<br/>Двери из полного профиляпрофилу</p> |
|    | <p>Emisja pyłków<br/>Pollen emmission<br/>Feinstaubemission<br/>Эмиссия CO</p>   |    | <p>Szyby łączone bez szprosa - lewa<br/>Joined glass without holding iron brackets - left<br/>Zwei Scheibe ohne Sprosse - links<br/>Стекла соединены, без перемычки - стекло слева</p>     |  | <p>Glass system<br/>System glass<br/>Glass-System<br/>Двойное стекло</p>  |
|    | <p>Temperatura spalin (°C)<br/>Temperature (°C)<br/>Abgastemperatur (°C)<br/>Температура (°C)</p>  |    | <p>Szyby łączone bez szprosa - prawa<br/>Joined glass without holding iron brackets - right<br/>Zwei Scheibe ohne Sprosse - rechts<br/>стекла соединены, без перемычки - стекло справа</p> |   |   |
|    | <p>Średnica czopucha (mm)<br/>Diameter (mm)<br/>Rauchrohrdurchmesser (mm)<br/>Диаметр дымохода (мм)</p>  |    | <p>Przód i tył<br/>back side (tunel) glass<br/>Scheibe vorne und hintere Zusatztür<br/>Двухсторонняя</p>   |   |   |
|  | <p>Klasa energetyczna<br/>Efficiency class devices<br/>Energieklasse<br/>Энергетический класс</p>  |  | <p>Stal<br/>Steel<br/>Stahl<br/>сталь</p>  |   |   |
|  | <p>Wkład kominkowy spełnia normy BlmschV 2 BlmschV 2<br/>Fireplace insert meets BlmschV 2 norms and regulations<br/>Kamineinsatz erfüllt die BlmschV Stufe 2<br/>Каминная топка соответствует BlmschV 2 нормам BlmschV 2</p> |  | <p>Żeliwo<br/>Grey cast iron<br/>Graues Gusseisen<br/>чугун</p>  |   |   |
|  | <p>Kominek idealny do domów z rekuperatorami<br/>Ideal for homes with heat recovery units<br/>Der ideale Kamin zu den Häusern mit den Abhitzeverwerter<br/>Для домов с энергосберегающими технологиями</p>                   |  | <p>Acumotte<br/>Acumotte<br/>Acumotte<br/>Acumotte</p>   |   |   |
|  | <p>Spełnia normy Eco Design 2022<br/>Complies with the eco design 2022 requirements<br/>Erfüllt die Ökodesign 2022 Normen<br/>Соответствует нормам Eco Design 2022</p>   |  | <p>Kafel<br/>Dutch-tile<br/>Kachelöfen<br/>Кафель</p>  |   |   |

UŁOTKI/KOZY  
/PLEN/DE/RU



5 903950 049912

**Kratki.pl Marek Bal**

ul. Gombrowicza 4, Wsola, 26-660 Jedlińsk, Polska

tel. 00 48 48 389 99 00, 00 48 48 384 44 88, fax 00 48 48 384 44 88 wew. 106

[www.kratki.com](http://www.kratki.com)

[www.facebook.com/kratkipl](https://www.facebook.com/kratkipl), [www.youtube.com/kratkipl](https://www.youtube.com/kratkipl)